

A publication of the
National Wildfire
Coordinating Group



NWCG Standards for Wildland Fire Chainsaw Operations

PMS 212

JUNE 2022



NWCG Standards for Wildland Fire Chainsaw Operations

June 2022
PMS 212

The *NWCG Standards for Wildland Fire Chainsaw Operations* establishes national interagency standards for chainsaw operations on wildland fires.

- Meets or exceeds all Occupational Safety and Health Administration (OSHA) 1910.266 Logging Standards.
- Ensures that risk management is incorporated into all aspects with an emphasis on open communications.
- Promotes safe and standardized chainsaw methods, techniques, and procedures for chainsaw operators from participating agencies.
- Provide consistent interagency guidance, common terms, definitions, and standardized procedures for wildland firefighting chainsaw use.
- Provides a standardized framework for current and future chainsaw training curriculum.
- Includes optional crosscut saws in [Appendix C](#).
- Member agencies have agreed to meet or exceed the standards found within this document for certification of sawyers.

The National Wildfire Coordinating Group (NWCG) provides national leadership to enable interoperable wildland fire operations among federal, state, tribal, territorial, and local partners. NWCG operations standards are interagency by design; they are developed with the intent of universal adoption by the member agencies. However, the decision to adopt and utilize them is made independently by the individual member agencies and communicated through their respective directives systems.

Table of Contents

Chapter 1 – Well-Being and Human Factors	1
Physical Well-Being.....	1
Mental Well-Being.....	1
Human Factors	2
Chapter 2 – Safety, First Aid, and Personal Protective Equipment	4
Occupational Safety and Health Administration (OSHA).....	4
First Aid Policy and Training Requirements	4
First Aid Equipment.....	4
Personal Protection Equipment (PPE)	5
Work Area Control.....	6
Emergency Evacuation Plan	7
Lessons Learned and Importance of Close Calls	7
Fuel Geysers Mitigation	8
Chapter 3 – Complexity, Size Up, and Risk Management	9
Complexity.....	9
Size Up Procedures	11
Risk Management.....	13
Chapter 4 – Tree Anatomy and Defects Contributing to Failure	14
Tree Anatomy.....	14
Decay Types.....	15
Root Damage.....	16
Tree Damage Identifiers.....	17
Chapter 5 – Chainsaw Components, Maintenance, and Repairs	25
Equipment	25
Maintenance	30
Chainsaw Repairs.....	35
Chapter 6 – Basic Saw Operations and Handling	38
Starting a Chainsaw.....	38
Transporting a Chainsaw.....	39
Safe Handling.....	40
Sawyer/Swamper Teams	42
Chapter 7 – Brushing, Limbing, and Bucking	44
Cutting Area Safety.....	44
Brushing.....	45
Limbing.....	46
Bucking	46
Chapter 8 – Directional Felling	50
Standards.....	50
Narrative.....	50
Hazardous Tree Risk Refusal Practices	50
Develop a Falling Plan.....	51
General Felling Operations	54
Types of Undercuts	54
Felling Away from the Natural Lean	61

Chapter 9 – Advanced Felling	63
Standards	63
Narrative.....	63
Large Diameter Tree Felling.....	63
Leaner Trees.....	70
Hang-up Trees.....	71
Limb-Tied Trees.....	76
Steep Slopes.....	76
Fire-Damaged Trees.....	77
Appendix A: Common Sawyer Specific Duties	81
Prepare.....	81
Mobilize	82
Build the Team.....	83
Communicate and Coordinate.....	83
Manage Risk	84
Demobilize.....	87
Common Sawyer Resources:	88
Appendix B: Advanced, Intermediate, and Basic Faller (FAL1, FAL2, and FAL3) Position Standards.....	90
Advanced Faller (FAL1).....	90
Intermediate Faller (FAL2).....	95
Basic Faller (FAL3).....	99
Appendix C: Crosscut Saws.....	102
Saws	102
How a Saw Cuts.....	104
Maintenance.....	105
Troubleshooting	106
Brief Overview of Saw Filing Procedures	107
Crosscut Bucking.....	108
Single or One-Person Bucking Advantages.....	109
Two-Person Cutting.....	110
Crosscut Felling.....	111

Chapter 1 – Well-Being and Human Factors

A high percentage of occupational accidents can be attributed to human factors. Accidents that occur in the workplace are caused by both unsafe acts and unsafe conditions. The physical and mental conditions of employees are just as important as the protective clothing they use or saw ergonomics performed. A successful wellness program promotes individuals to change unhealthy habits and improve physical and mental health, contributing to a reduction in injuries that leads to lower worker's compensation costs.

Fitness and Work Capacity, PMS 304-2, <https://www.nwcg.gov/publications/304-2>.

Physical Well-Being

Standards

- Sawyers must be physically fit and successfully pass the wildland fire work capacity test as defined in the *NWCG Standards for Wildland Fire Position Qualifications*, PMS 310-1, <https://www.nwcg.gov/publications/310-1>.
- Sawyers must understand how physical well-being impacts their safety and performance on the fireline.

Narrative

Over a short period of time, operating a 12-to-23-pound chainsaw can become physically challenging. As fatigue sets in the risk of injury greatly increases. Personal fitness and strength directly affect the ability to grasp, balance, and control a chainsaw. As sawyers gain experience the chainsaw becomes an extension of the body. It is imperative that sawyers have enough fitness to control a chainsaw safely and effectively.

- When operating a chainsaw, it is crucial to note that this task is a balance of using technique and muscular fitness to accomplish cutting objectives.
- Proper posture and muscular strength of the lower body, torso, and shoulders provide a stable foundation from where the chainsaw can be manipulated.
- The necessary muscular endurance and proper chainsaw handling should be emphasized to prevent a lapse in control of the chainsaw.

For more information on muscular fitness for firefighting refer to *Fitness and Work Capacity*, PMS 304-2, Chapter 4, <https://www.nwcg.gov/publications/304-2>.

Mental Well-Being

Standards

- Sawyers recognize the impacts of mental health on job performance and safety.
- Sawyers must understand how mental well-being impacts their safety and performance on the fireline.

Narrative

“When you have your saw in hand, your full attention must be on the task at hand!” – Randy Anderson

Sound mental health impacts our ability to stay focused and maintain mental engagement throughout an operation. Mental health includes life satisfaction, self-acceptance, sense of purpose, positive identity, feeling connections to surroundings, and resiliency.

- Before you pick up your saw, consider your current state of mind. Even when intentions are to focus on a work assignment, mental factors can intervene.

It just takes one moment of distraction for a negative outcome to occur. If a sawyer is feeling distracted, use the opportunity to pass off the chainsaw.

See yourself as stronger for acknowledging that it is ok to not be ok.

Human Factors

Standards

- Sawyers recognize the impacts of human factors and crew dynamics on job performance and safety.
- Sawyers understand they are empowered to turn down saw assignments based on their comfort level, knowledge, skills, and abilities.
- Sawyers will determine whether the tree needs to be felled, limbed, or bucked. Determine if they have the equipment, experience, and ability to safely meet fireline objectives. Decide if there are other options such as moving the fireline, equipment use, or creating no-work zones.

Narrative

“Have we created a climate that prompts them to finish the cut based on their sense that they now, own the tree?” – Strawberry Action Plan

Human factors are the combined effect of personal thoughts, beliefs, behaviors, abilities, strengths, and limitations on how one performs a task. Many chainsaw accidents have been influenced by the effects of human factors on decision making.

- Every sawyer has the right to turn down an assignment. The sawyer’s supervisor needs to support when they decline an assignment due to risk. For more information refer to the *NWCG Incident Response Pocket Guide (IRPG)*, PMS 461, How to Properly Refuse Risk, <https://www.nwcg.gov/publications/461>.
- It is often the perception that a sawyer is responsible to complete a saw operation once started. This viewpoint influences a sawyer to continue an ineffective saw operation without acknowledging that their level of risk has increased. Every sawyer should understand it is acceptable to walk away from any point of the saw operation. This includes the size up through unforeseen hang ups or other dangerous circumstances.

Both the military and the wildland fire community promote tactical pauses. This is the practice of pausing at critical points of an operation to reevaluate the situation and identify any associated risks that may evolve but have gone unnoticed. Due to the inherent cultural norms of wildland fire fighting we often operate at a high tempo focused on completing a task or mission. Firefighters are good at identifying and mitigating hazards prior to an operation but may fail to acknowledge the increased level of risk that evolves during the operation.

Some examples of processes for reevaluating throughout an operation.

- Stop, Look, Listen, Think – US Military
- Life First – Stop, Think, Talk Act – United States Forest Service (USFS)
- Switchback – Stop, Breathe, Re-think, Plan – USFS
- Developing Thinking Sawyers
- How Thinking Sawyers Recover
- OODA loop – Observe, Orient, Decide, Act – US Air Force



Chapter 2 – Safety, First Aid, and Personal Protective Equipment

Occupational Safety and Health Administration (OSHA)

Standards

- Sawyers understand how OSHA standards influence saw operations and agency policy.
- Sawyers cut within their qualification level unless under the direction of a higher qualified sawyer.

Narrative

OSHA’s mission was directed from the Occupational Safety and Health Act of 1970. Congress created OSHA to ensure safe and healthful working conditions for working men and women by setting and enforcing standards by providing training, outreach, education, and assistance.

All content within the *NWCG Standards for Wildland Fire Chainsaw Operations* meets or exceeds all OSHA 1910.266 Logging Standards, <https://www.osha.gov/laws-regs/regulations/standardnumber/1910/1910TableofContents>.

Further Information on 1910.266, <https://www.osha.gov/enforcement/directives/cpl-02-01-019>.

First Aid Policy and Training Requirements

Standard

- Each sawyer must have received training and hold current certification in First Aid and CPR.
- In addition to the First Aid requirements, sawyers must be made aware of the potential and first aid for insect bites, stings, and the hazards of insect and tick-borne diseases. [29 CFR 1910.266(I)(3)(iv)].

First Aid Equipment

Standard

- All work sites will have a first aid kit with the following items on site. Number of first aid kits must be commensurate with the number of employees engaged at the work site.

Narrative

Federal Agencies first aid equipment requirements for chainsaw operations.

OSHA Standard 1910.266 Appendix C, <https://www.osha.gov/laws-regs/regulations/standardnumber/1910/1910.266AppA>.

The contents of the first aid kit listed below should be adequate for small work sites, consisting of approximately two to three employees. When larger operations or multiple operations are being conducted at the same location, additional first aid kits should be provided at the work site or additional quantities of supplies should be included in the first aid kits:

1. Gauze pads (at least 4 x 4 inches).
2. Two large gauze pads (at least 8 x 10 inches).

3. Box adhesive bandages (band-aids). *
4. One package gauze roller bandage (at least two inches wide).
5. Two triangular bandages. *
6. Wound cleaning agent such as sealed moistened towelettes. *
7. Scissors. *
8. At least one blanket. *
9. Tweezers.
10. Adhesive tape. *
11. Latex gloves. *
12. Resuscitation equipment such as resuscitation bag, airway, or pocket mask. *
13. Two elastic wraps. *
14. Splint. *
15. Directions for requesting emergency assistance.

**Included in NFES 20 – 25-person First Aid Kit*

Additional Recommendations:

- Tourniquet / emergency bandages (Israeli).
- Back board / spine mobilization transport.
- Basic life support trauma gear – based on Emergency Medical Services (EMS) qualifications.
- Automated external defibrillator (AED).

Personal Protection Equipment (PPE)

The chainsaw PPE requirements from the Standards for Interagency Standards for Fire and Aviation Operations Chapter 7, <https://www.nifc.gov/standards/guides/red-book>, are based on compliance with the OSHA Logging Standard 1910. [https://www.osha.gov/laws-regs/regulations/standardnumber/1910/1910.266#1910.266\(d\)\(1\)\(vi\)](https://www.osha.gov/laws-regs/regulations/standardnumber/1910/1910.266#1910.266(d)(1)(vi)).

Standards

- Chaps – Leg Protection, all chainsaw operators will wear chainsaw chaps meeting the USFS Specification 6170-4F or 4G. Chaps must overlap boots by minimum of two inches yet not be so long as to create a tripping hazard. Leg straps will be tightened to achieve leg protection.
- Gloves – All sawyers will wear leather/flame resistant hand protection which provides adequate protection from puncture wounds, cuts, and lacerations.
- Helmet – All sawyers will wear a helmet meeting the current (NFPA) 1977 Standard on Protective Clothing and Equipment for Wildland Fire Fighting requirements, or equivalent helmet meeting the current ANSI Z89.1 Type 1, Class G.

- Eye and Face Protection – Eye protection will be worn during all chainsaw operations involving cleaning and fueling (meeting ANSI Z87.1). Steel mesh safety goggles are allowed only during falling and bucking operations. Face shields are only required where face protection has been identified in a Job Hazard Analysis/Risk Assessment (JHA/RA). Face shields must meet ANSI Z87.1.
- Boots – Sawyers are required to wear approved wildland fire boots.
- Hearing Protection – Sawyers and swampers must be provided with and wear, hearing protection.
- Clothing – Sawyers must wear wildland fire approved long sleeve flame resistant shirt and pants.

Narrative

All sawyers need to establish regular PPE inspection protocols. PPE functions best when it is clean. Follow the inspection, cleaning, and service life recommendations provided by the manufacturer.

Work Area Control

Standard

- Sawyers understand how to establish and maintain work area control.

Narrative

“42% of the time, the person struck was not cutting—including in 5 of the 8 fatalities.” 2014-2019 Tree Felling Accident Analysis, <https://www.wildfirelessons.net/orphans/viewincident?DocumentKey=06ad7d20-6d6f-4440-894c-397f3a6d876a>

The chainsaw operator is ultimately responsible for controlling the work area. No one shall be permitted in the secured felling area without the authorization of the faller. Supervisors need to support sawyers on work area control measures.

The faller must establish a safe area outside the secured area and direct EVERYONE to remain there until all felling procedures are completed and a verbal confirmation such as an "all clear" has been communicated.

- Employees shall be spaced, and the duties of each employee shall be organized so the actions of one employee will not create a hazard for any other employee. 1910.266(d)(6)(I).
- A work area perimeter should be established, if practical, it should be the equivalent of two tree lengths of the material being felled in all relevant directions. This perimeter must be maintained by the faller during all tree felling operations.
- Avoid working directly below felling or bucking operations.
- Competent lookouts shall be established and maintained by the faller at all major access points, including roads, and trails that provide access to the secured work area.
- The faller will ensure to identify and make known, all hazards that may remain at a hazard tree that could not be mitigated such as hang ups, unstable logs, or other dangers before approving access into the work area.

Emergency Evacuation Plan

Standards

- Sawyers understand the importance of a communication and emergency evacuation plan for each work site.

Narrative

An emergency evacuation plan that includes the following components should be in place during all chainsaw operations:

- Site location.
- Communication methods and plans.
- Primary and secondary transport routes (*never rely solely on air evacuation*).
- On-site medical personnel and equipment.
- Nearest ambulance services.
- Hospitals.

The following forms and publications can assist in the development of an emergency evacuation plan:

- Medical Plan (ICS 206 WF), <https://www.nwcg.gov/publications/ics-forms>.
- Planning for Medical Emergencies, *NWCG Incident Response Pocket Guide (IRPG)*, PMS 461, <https://www.nwcg.gov/publications/461>.
- *Interagency Standards for Fire and Fire Aviation Operations* (Red Book), https://www.nifc.gov/policies/pol_ref_redbook.html.

Lessons Learned and Importance of Close Calls

“Highly Reliable Organizations (HROs) are unique because they self-organize to encourage and reward the self-reporting of errors...on the explicit recognition that the value to the organization of remaining fully informed and aware of the potentiality for the modality of error. HROs become central locations for organizational learning.” – Karl Weick

Standards

- Sawyers understand the importance of operating in a learning culture where accidents are reported and analyzed to develop lessons learned.
- Sawyers make predictions about the effects of each cut and regularly compare outcomes with predictions to improve prediction certainty.
- Sawyers utilize hung tress, missed lays, and stump analysis to improve their understanding and experience as fellers.
- Sawyers utilize near misses to increase awareness of contributing conditions of accident precursors.

A successful saw organization is one that shares its lessons learned. Make a career commitment to continually learn about chainsaw safety.

Narrative

The occurrence of cut chaps is a serious near miss and a supervisor and sawyer should be in agreement that cut or nicked chaps warrants immediate feedback that a sawyer is not executing good saw control and the next outcome could involve significant bodily harm.

Cut chaps are an example of a lesson learned that others can benefit from.

Sources of Lessons Learned

- *2004-2019 Tree Felling Accident Analysis*, <https://www.wildfirelessons.net/orphans/viewincident?DocumentKey=06ad7d20-6d6f-4440-894c-397f3a6d876a>.
- Lessons Learned Center, <https://www.wildfirelessons.net/home>.
- Six Minutes for Safety, <https://www.nwcg.gov/committee/6mfs>.

Fuel Geyser Mitigation

Standards

- Sawyers understand the causes and mitigations for preventing fuel geysering events.
- Sawyers understands the OSHA (1910.266) requirements for refueling chainsaws.

Narrative

Over the past several years sawyers have experienced pressurized chainsaw fuel tanks where spraying fuel is released and contacts the operator after the chainsaw fuel cap is opened. Some instances have resulted in serious injuries and/or damage to the chainsaw. Although not common, investigations have revealed it occurs with greater frequency than reported. If you experience a geyser with or without injury, report the incident at the Fuel Geyser Incident Reporting Form:

<https://www.nwcg.gov/committees/equipment-technology-committee/fuel-geyser-incident-reporting-form>.

Fuel geysers can happen anytime when there is fuel, heat, and pressure in small gasoline-powered engines including chainsaws and fuel transport containers.

Geyser Mitigations

- Check fuel levels before opening a fuel cap. Fuel levels greater than half a tank may geysers.
- Always assume fuel tanks and fuel containers are pressurized. Open cap slowly expecting the fuel to geysers and direct potential spray away.
- Cover the cap with a rag to contain potential fuel geyser spray.
- Be extra vigilant when equipment begins to run poorly with fuel levels above half a tank.
- Move at least 20 feet or more from any heat source and 10 feet from the fueling area.
- Winter fuel is believed to be a contributing factor, do not use fuel older than one month.

Chapter 3 – Complexity, Size Up, and Risk Management

Complexity

Complexity is a characterization of the cutting situation that determines the level of knowledge, skill, and certification level a sawyer needs based on how they will manage all the components of the cutting operation. Complexity is different from managing the risks of the operation, but rather how all aspects of the sawing operation will be managed.

Standard

- Sawyers will effectively determine the complexity of a cutting operation and realize that it is one of the most important processes to understand and implement.

Narrative

A hazard and the extent to which a sawyer can mitigate a hazard, influences the risk of the operation. Risk is the probability and consequence of a hazard causing harm. Mitigations can reduce severity thus changing the overall risk level. However not all risk can be lowered. If the hazard cannot be mitigated, the sawyer must reassess the objective of the operation.





Are these external factors influencing your saw operations?

Human Factors (stress, fatigue, relationships at home, etc.) Yes No / **Values at risk** (cabins, campgrounds, etc.) Yes No

Environmental Factors (weather, fire, etc.) Yes No / **Work Zone** (work tempo, remote, medical extraction difficult, etc.) Yes No

If you answered yes to many of the factors above, are you really mentally prepared to cut this tree?

Complexity

	LOW			HIGH	
Objective	<ul style="list-style-type: none"> Options available to fell tree to multiple lays to meet objective 	<ul style="list-style-type: none"> Options available to fell tree within 45 degrees of intended lay to meet objective 	<ul style="list-style-type: none"> Tree must be felled within 5 degrees of intended lay to meet objective 	No Safe Lay - STOP Reevaluate objective!	
Hazards	<ul style="list-style-type: none"> Minimal hazards are present that will impact cutting operation 	<ul style="list-style-type: none"> Hazards are present but can be easily identified and understood 	<ul style="list-style-type: none"> Hazard(s) are present but may be mitigated by altering cut plan and technique. 	No Escape from Hazards STOP Reevaluate objective!	
Leans	<ul style="list-style-type: none"> Less than 3 ft. of side lean Less than 3 ft. of head lean Back lean does not exist with intended lay Binds - Known low release of energy Leans or binds do not require wedging or sequence of cuts 	<ul style="list-style-type: none"> 3 to 5 ft. of side lean 3 to 5 ft. of head lean 1" of lift to overcome back lean required Leans or binds may require wedging 	<ul style="list-style-type: none"> Greater than 5 ft. of side lean Greater than 5 ft. of head lean 1 to 2" of lift required to overcome back lean Binds - High release of energy expected 	More than 2" of lift required to overcome back lean - STOP Reevaluate objective!	
Escape Plan	<ul style="list-style-type: none"> Escape path is clear Multiple escape paths - Easily accessed 	<ul style="list-style-type: none"> Access to escape path could be limited i.e., Only one escape path available 	<ul style="list-style-type: none"> Access of escape path(s) could be difficult and/or in steep terrain 	No Escape Path - STOP Reevaluate objective!	
Cutting Plan	<ul style="list-style-type: none"> Single cut undercut Green or Sound Hinge Cuts can be made from 1 side of tree - escape to same side 	<ul style="list-style-type: none"> Compromised fiber Double cut undercut / backcut Requires moving from side to side of tree 	<ul style="list-style-type: none"> Cut plan requires more than double cut Terrain makes cut plan implementation difficult Cut plan requires an elaborate sequence of cuts and wedging plan Fiber has been significantly compromised i.e., rot, fire weakened Hung-up or limb-locked trees 	Cutting plan does not meet sawyers ability - STOP Reevaluate objective!	

The factors identified above are used as a guide to determine the overall complexity of a cutting operation while going through each step of the Size up process. These different factors are not to be considered definitive when determining complexity, but rather a tool that assists sawyers when evaluating the complexity of a cutting operation and to ensure that it aligns with their knowledge, skill, and certification level.

Size Up Procedures

Standards

- Sawyers will complete a procedural size up prior to engaging in chainsaw operations.
- Sawyers understand the relationship of the ongoing size up, human factors, environmental hazards, risk, and complexity.

Narrative

Many accidents have been attributed to poor size up or missed steps during the evaluation of the tree to be felled, limbed, or bucked. A procedural approach is required to assure all involved in the cutting operation understand the cutting plan. Prescribed size-up procedures assure sawyers evaluate each cutting situation they encounter in an organized and consistent manner.

The minimum components of a procedural size up include:

- Objective of the cutting operation.
- Known hazards of the operation.
- Recognize leans or binds present.
- Develop an escape plan.
- Develop a cutting plan.

Objective

The objectives will set the overall intent for the cutting operation at the work site and outline the sequence of events at the work area level. The work area may be a single tree felling scenario or a routine chainsaw operation along a piece of fireline. The objectives are critical in developing a cutting plan to determine where each cut piece will end up. Predict the outcome of each cut and develop objectives to sequence the work safely and efficiently. Objectives may include development of felling, limbing, bucking, and brushing plans.

Hazards/Obstacles

Identify and Communicate the Hazards/Obstacles:

- Weather hazards – Outflows winds, general winds, approaching storms, precipitation etc. evaluate crown movement from wind and determine impacts on cutting operation.
- General tree and/or stand health hazards – Species or tree type weaknesses, disease, or damage from fire/weather events as well as your experience from previous areas etc.
- Terrain Hazards – Landscape presents many additional hazards such as steep slopes, rocks, soil moisture, brush, general ease of movement across terrain, and movement of cut material across terrain.
- Overhead Hazards – Fire, rotten top, widow makers, and loose bark, tied limbs, leaners, and hung trees present.
- Cutting Operation Hazards – Fire, coniferous, or deciduous species, sound, or rotten wood, live, or dead tree, hinge wood (hinge wood will be used in place of the term holding wood) integrity, hollow tree, bees, poison plants, or spring poles.
- Values – Buildings, equipment, improvements, or other values to be avoided.

- Cutting Area – Hazards associated with people or equipment in the cutting area and ease of cutting area control.
- Equipment limitations – Bar length, sufficient fuel/oil supply, saw condition, wedges, and poulder available.
- Time – Adequate time to meet objectives.
- Human Factors – Physical and/or mental condition, production pressure.

Leans, Binds, and Weight

Identify the Lean and Weight of the Tree or Binds Associated with the Proposed Cut Sequence:

- Determine lean of a standing tree and calculate, in feet, the amount of head/back lean and side lean away from the center of the tree butt.
- Predict where a tree would land if it fell over on its own this identifies the “bad” side of the tree.
- Consider the weight of a tree when developing a cutting plan. When cutting hard woods for example white or red oak, the crowns, and their structure can be heavy enough to counteract a lean.



- Determine binds in a log to be bucked, spring poles, limbs, or brush to be removed.
- Predict tree reaction to cut sequence in relation to binds, spring poles, and brush removal.

Escape Paths

Based on lean and bind analysis and predictions, identify escape paths for the cutting situation:

- Determine the good and bad side of the tree, log, spring pole, limb, or brush.

Cutting Plan

Reevaluate the objective and develop a cutting plan to determine which techniques will be used to achieve the objective.

- Face notch type – conventional, Humboldt, or open-face.
- Hinge composition – position, length of hinge, depth of hinge.
- Stump shot designation – determine the amount of stump shot needed.
- Backcut type – traditional or modified.
- Wedge placement – including number of wedges and felling axe placement.
- Sawyer communication – crew members, swampers, or crosscut sawyer partner.
- Analysis of outcome.

Risk Management

There are many locations where extreme conditions exist because of drought, insects, disease, and fire – related tree mortality. Sawyers should be cautious to not normalize working under these extreme conditions as this can create a hazard to the sawyer and those around the sawyer.

JHA/RAs are formalized documents listing every identified risk, hazard, and mitigation. JHA/RAs provide an excellent opportunity for all involved to discuss the associated risks and how to mitigate them or decline if acceptable mitigations are not met.

Risk management process is as follows:

- Step 1 Situation Awareness – Tree size up conducted, and outcome predictions obtained.
- Step 2 Hazard Assessment – Identify size-up components that are considered hazardous and discuss with your saw partner.
- Step 3 Hazard Control – Identify mitigations to reduce the hazards to acceptable levels of risk.
- Step 4 Decision Point – Is it worth the risk? Not cutting a tree down is an acceptable decision.
- Step 5 Evaluate – Evaluate the outcome asking what worked well and what needs improvement?

Good Side/Bad Side of Tree and Where to Stand

The phrase “good side, bad side” refers to which side of the tree or log has the most hazards. Highly complex operations may only have a bad side and a worst side. Sawyers should always finish their cut and utilize an escape path on the good or better side of a tree or log. Being under the naturally weighted lean of a standing tree should always be considered as the bad side and should be completed first with the finishing cuts and escape path on the good side.

Sawyers have been injured or killed due to their escape path being on the bad side of a tree. They were struck attempting to escape when cutting sequences or tree conditions lead to unpredicted outcomes.

Standard

- Sawyers will identify the good and bad side of the tree and incorporate into the cutting plan.

Narrative

The good and bad sides of a tree are a function of tree lean, tree condition, and defect, topography, vegetation, and location of the sawyer. Tree lean is expressed in two ways, natural lean, and calculated lean. The difference between the good side and the bad side can be a matter of a few feet in distance.

- Natural lean is where gravity would take the tree if it were to just fall over. It is where the combined mass of the bole, limbs, and foliage is located, relative to the center of the base of the tree.
- Weight distribution higher up in the tree has more influence on the natural lean than weight lower in the tree.
- Calculated lean is the amount of front to back and/or side-to-side lean relative to the objective. An accurate lean assessment is necessary to fall a tree towards the intended target. This information is also used when deciding where the bad side of the tree is.
- Side-to-side lean is determined by standing in-line with the objective and the intended lay, observing from a tree length away if possible.

Front to back lean is determined by standing 90 degrees to the objective and the intended lay, observing from a tree length away if possible. See [Leaner Trees](#) in Chapter 9.

Chapter 4 – Tree Anatomy and Defects Contributing to Failure

Understanding basic tree anatomy, tree defects, and how decay impacts tree stability can improve tree size-up skills and complexity determination. Sizing up tree defects that relate to tree failure is not always straight forward and varies by tree species. While dead trees may be the most obvious for structural defects, often live trees have structural defects that may not be noticed by the untrained eye.

Tree Anatomy

Standard

- Sawyers identify stand conditions, discuss their impacts on size up and complexity to adjacent forces.
- Sawyers recognize tree anatomy and defects and their relationship to the cutting operation size up and complexity determination.
- Sawyers recognize the additional risks that can be associated with standing dead trees and determine the condition of the snag during size up.

Narrative

Hardwoods and Softwoods

Tree species are grouped by angiosperms and gymnosperms.

Angiosperms are typically flowering, broadleaved trees, most are deciduous, and considered hardwoods. Hardwoods typically are slow growing with dense and less flexible fibers.

Gymnosperms are typically cone-producing, needle bearing conifers. They are mainly evergreen trees with a few exceptions and are considered softwoods. Relative to hardwoods, softwoods grow much faster with softer and more flexible fibers.

For the purposes of hazard tree identification hardwoods and softwoods can be broken down into four major groups.

- *Resinous Tree Species* – Douglas-fir, larch, pine, and spruce. These trees are generally longer lived and less prone to decay. They have more structural stability even with severe defects. When wounded the resin response covers the wound and can protect the tree from decay fungi entering the wound. Generally, larch, western white pine, and larger Douglas-fir snags can stand for decades.
- *Decay Resistant Species* – Cedar, juniper, and redwood. Hinge wood for live cedars and juniper is typically more brittle, which can effect directional felling control. Only a few specialized fungi are capable of causing severe decay in the heartwood. However, when present, decay can be severe such as in western red cedar. Often dead tops in these species are solid and can persist for decades.
- *Non-Resinous Conifers* – Hemlock and true fir. Wounds are easily colonized by decay fungi. Dead tops in these species rapidly decay and fail. These species are short-lived snags due to decay.

- *Deciduous Trees* – Aspen, oak, maple, alder, and cottonwood. Cottonwood, aspen, and alder are generally short-lived and prone to decay. Maple, oak, and several other deciduous tree species groups are long lived and many are less prone to decay. Sapwood and heart wood is brittle which affects the integrity of hinge wood and diminished felling control when a tree closes on its hinge.

Sapwood and Heartwood

Trees are comprised of both sapwood and heart wood.

- Sapwood is the outer layers of a stem, which in a live tree, are composed of living cells called xylem that conduct water up the tree. Living sapwood can isolate areas of decay fungi to prevent spread. Sapwood of dead trees generally decays quickly.
- Heartwood is the inner, nonliving part of a tree stem that is altered to a protective state as cells die in the normal growth process. Heartwood provides much of the structural support. Fungi can decay heartwood if given a mode of entry into a tree. Generally, heartwood decays are more common in older trees and can take years to degrade before impacting the structural integrity of the tree.

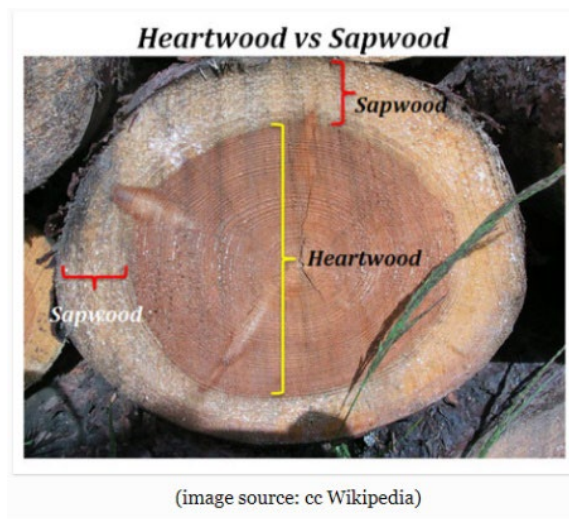

Decay Types

Specialized fungi are capable of decaying heartwood and sapwood. Since sapwood is living tissue, very few fungi can colonize the sapwood and cause decay. However, upon tree death sapwood is easily colonized and decays quickly. Heartwood is more easily decayed in living trees by specialized fungi. In general, live trees tend to slowly decay from the inside out since decay is isolated to the heart wood while dead trees decay from the outside in.

Physical Damage

Physical damages can occur from mechanical damage, fire, lightning, snow loading, etc. Damages to trees that remove the bark can create an entry point for decay fungi. The likelihood of being infected after wounding depends on species and if the tree is resinous or not.

Biological Damage

Biological damages are typically caused by disease or fungi followed by decay and structural instability. Some may be induced through physical damage and can depend on tree species, stand structure, and age. Biological defects tend to be clumped across geographic locations by species and age.

Root Damage

Root damages that cause tree instability can be attributed to both physical and biological damage. Physical or environmental factors include broken roots, fire, erosion, fluctuating ground water tables, exposure to the elements, and human/animal impacts. Roots damaged by physical problems typically become subject to decay. Biological damages are typically caused by disease or fungi, which can lead to root decay. Root problems can be difficult to assess but there are clues to help identify hidden dangers.

Root Instability Causes

- Root disease.
- Undermined/severed roots.
- Waterlogged sites.
- Root sprung trees (tree has shifted causing the root system to lift) or severely leaning trees.
- Fire.

As a general rule, tree stability requires preservation of at least 50% of a tree's root structure within the dripline of the canopy.

Tension and Compression Roots

Roots that are growing uphill from a tree are under tension. Roots growing downhill from a tree are under compression. The tension roots are pulling the tree up while the compression roots are pushing the tree up. On a tree with a lean, the roots against the lean are under tension while those towards the lean are under compression.

- Root damage to compression roots is generally not as serious as damage to tension roots.
- You should not work downhill or under the lean of a tree where the tension roots have been compromised.

Roots under tension have approximately twice the strength as roots growing under compression making the location of root defects very important to trees growing on a slope.

Root Evaluation

It is important to look around the base of a tree for compromised roots. Pay attention to trees that have developed a recent lean. Examine for recent up lifting of the root plate for cracking in the soil which would indicate recent movement and a tree in the process of failing, these are often evident after windy conditions, especially when soils are saturated.

Root diseases are more difficult to identify. Root diseases are caused by specialized fungi and can be difficult to detect on an individual tree, instead the pattern of mortality and tree decline in the stand is a key diagnostic feature that root diseases are present.

- If the trees in the surrounding area are dead, fallen over at the base and lack any root ball, have mushrooms or conks at the root collar, or show other signs of stress and decay, root problems may be the cause.
- Some trees with root disease may have resin/sap flow at the base. Green trees may exhibit signs of root damage through chlorosis (yellowing of needles), thinning of foliage, or overabundance of cone production. If you identify signs of root disease, all trees in that area should be suspect. The importance of different root diseases depends on your geographic location and the conifer tree species affected. Consulting local field guides can help with identification.

Tree Damage Identifiers

Butt and Bole Defects

The outer and inner bark of a tree act as a protective layer that inhibit decay fungi from entering. If a tree is healthy with intact bark, fungi are typically unable to penetrate directly into the tree, making internal rot unlikely. Damage to a tree that kills or removes the bark and cambium creates openings for fungi to exploit.

Indicators to examine the butt and bole of trees for decay:

- Missing or loose bark.
- Open wounds caused by logging activity, fire, rolling rocks, human activities, or struck by another falling tree.
- Cracks or splits along the bole of the tree, especially those where there is exposed wood and evidence of decay behind the crack.
- Broken tops.
- Lightning damage with missing bark or wood down the length of the tree or a spiral scar (look for longitudinal cracks into the wood and/or old scars where decay has developed).
- Fire damage where part of the bole is consumed.
- Insect or animal damage.

Stem and Butt Decays

Two broad types of decay are heartwood decay and sapwood decay. Few fungi can infect and decay living sapwood. But once dead, sapwood is rapidly decayed much more quickly than heartwood.

Fungal fruiting bodies (conks or mushrooms) sometimes appear on the butt or bole of trees, indicating the presence of rot. Conks and mushrooms come in many shapes, sizes, and colors. Some are hard and woody, while others are soft to the touch. Conks can be an important visual indicator of internal decay and may indicate reduced structural integrity. In general, the presence, and location of conks means tree size up should include assessing for internal decay.

Figure: a) heart wood decay on aspen b) conk c) a superficial sap rot on recently killed ponderosa pine.



Cankers/Swelling

A canker is an area of dead bark or cambium on a tree that slowly expands outward through time. Fungi that cause cankers often enter through wounds or openings in the bark, such as branch stubs. Canker fungi kill the cambium just beneath the bark allowing for decay fungi to penetrate the deeper underlying wood. Cankers are typically localized and appear as missing or sunken areas of the bark and often appear discolored and weep sap. Portions of the trunk may also appear swollen. As the healthy portion of the tree continues to grow, the bark around the canker can deform and split.

Figure: a) western gall rust canker b) rust canker also known as hip canker on a lodgepole pine.



Stems or branches often fracture near cankers due to decay or deformed growth. Trees with cankers should be evaluated for associated internal wood decay, cracks, or other defects. Hypoxylon cankers in white trees contribute to tree mortality and compromises the structural integrity of the tree.

- If the bark is intact and tight there is likely no decay.
- If bark is loose or split, the wood underneath may be weak or decaying.
- If a tap of on axe sounds hollow, then decay is present.
- Cankers on pine species are often solid without decay, however they can have severely deformed growth that often leads to failure under high winds or snow and ice storms.

Cankers that encompass more than half of the circumference of the tree may often fail even if the exposed wood appears sound.

Wounds

Wounds that break the bark or branch can be entry points for decay fungi. Decay after wounding, is a slow process often taking several years to decades before increasing the probability of failure. A damaged stem can signify internal decay. Be aware of old wounds where the tree has grown over the damaged area which may cover internal decay. Development of decay varies between tree species.

Cracks and Splits

Cracks may be caused by lightning, wind shear, freezing temperatures, heartwood decay, and other natural causes. Wood behind cracks may be sound, decayed, or missing if decay is severe. Resinous tree species with recent cracks often have fresh pitch associated with it or exposed fresh wood. On dead trees, wood dries, and cracks. Lightning strikes are typically evident by a spiral crack extending down the stem. Trees with cracks should be suspect of internal decay and in the worst cases indicate a tree in the process of failing.

Figure: a) and b) Cracks that are vertical on the tree stem separating the stem into two halves along the wood grain can have a high likelihood of failure.



Tree Top Defects

Identifying tree top defects can be difficult at the base of a tree making it a good habit to inspect trees as you approach from a distance.

- Visually inspect the tops of trees in the area as part of your initial site assessment.

Dead Tops

Dead tops, sometimes referred to as spike tops, can occur in trees of any age or species but are more prevalent in older decadent stands. Broken treetops expose the internal wood fibers to the elements. As the wood fibers decay, they soften, and absorb moisture making stems heavy and susceptible to breaking. Before failure, tops often rot in place and are held by little or no sound wood.

- A gentle bumping or jarring of a top-killed tree may cause top failure calling for extreme caution when working near them.



If you identify dead tops be aware that other trees in the area may also have dead tops, but have grown new or multiple tops, making it more difficult to identify the hazard.

- Dead tops in pines, incense-cedar, western red cedar, juniper, and Douglas-fir that give evidence of long-term persistence are usually dry or resin-impregnated and generally hold for long periods of time.
- Species such as true firs, spruce, hemlock, and hardwoods are decay prone and fail much more rapidly and may absorb moisture adding additional weight leading to high-failure rates. Look for evidence of advanced decay in dead top such as cavity-nesting birds.

Multiple Tops or Codominant Stems

Multiple tops form when two or more lateral branches take over as a new leader to replace an old broken or dead leader. Multiple tops and codominant stems are often weaker than a single-stemmed top for a variety of reasons. In V-shaped unions, bark often forms a natural collecting point for snow, moisture, and organic matter which promotes decay. Look for evidence of cracking, pitching, or decay below the fork to indicate that the forks are separating.

- It is important to realize when cutting a tree with a dead top that when the tree moves towards its intended target the movement may cause the weakened top to break and come back towards the sawyer.

Figure: a) Forked tops with high-failure potential a) weeping/cracked hardwood b) cedar with open cracks. Forked tops with medium-failure potential c) ponderosa pine with embedded bark.



Branch and Limb Defects

Examine each tree in your working area for dead, dying, and damaged branches; even a small limb can be deadly. Living branches may also be weak or pose hidden dangers not readily visible. Wind, rain, snow, and ice loading can also contribute to limb failure.

Decay

Trees with conks, cracks, openings, weak branch unions, broken/hollow branch stubs and missing bark all need to be examined closely for evidence of decay.

Dead Branches

Trees often shed their branches naturally but may remain intact for many years. Visually follow the branch from the bole of the tree to the end of the limb. Dead branches are common but may be difficult to see in a live canopy. Side branches coming off the main branch or the end of the branch may also be dead and susceptible to failure.

Dwarf Mistletoe Brooms

Dwarf mistletoe is a parasitic flowering plant that causes a tree to produce heavy masses of dense branches and foliage and is typically found on conifers. These are commonly referred to as witches' brooms and can get quite large and heavy in some tree conifer species. In general, small brooms do not present a hazard.

- Large brooms may change the weight distribution of the tree and large dead brooms are prone to breakage under snow and ice loads, especially large brooms in Douglas-fir.

Figure: a) Hardwood trees tend to have more branch failures than conifer/softwood trees. b) Large broom.



Whole Tree Defects (Dead Trees or Snags)

Many factors can influence when a snag fails, including tree species, and pre-existing defects. Tree species decay at different rates for example, small dead trees contain a higher sapwood ratio and are likely to fail soon after tree death. Larger conifers have higher heartwood ratios and typically fall in pieces from the top down, over time.

- Large Douglas-fir, western white pine, western larch, Ponderosa Pine, and cedar can be slow to break down and remain standing for years.
- Cedars and junipers generally decay very slowly.
- Hardwoods, including cottonwoods, and aspen with large spreading crowns will have individual branch failures soon after death.
- Cottonwoods, alders, true fir species, and hemlocks all quickly decay and are short-lived snags.
- Lodgepole pine has been found to rapidly fail at the base of the tree instead of slowly breaking down further up the stem. Typically, half are on the ground within 9 years.

Dead Leaning Trees

Arched trees or those with a heavy lean have an increased likelihood of failure. The direction of a tree's lean indicates its most likely direction to fall and poses highly significant danger to anything within its target area.

Live Leaning Trees

Live leaning trees may offer visual clues about their stability.

- The most important thing to assess is if a tree has a recent or old corrected lean. A tree that has been leaning for a long time will often try to self-correct with the tree top sweeping upward to re-establish its vertical growth pattern.

For trees with new leans that have not self-corrected, examine the base of the tree and look for signs of an uplifting root plate and separating forest litter, duff, or uplifted soil on the side opposite of the lean which indicate recent movement.

- These trees are actively failing, and extra caution should be taken.
- Leaning or arched trees with no danger indicators may be perfectly safe to work around.

Determining if a lean is recent or older on old trees or trees with broken tops can be difficult and other indicators might need to be used to assess the stability of the tree. Leaning trees with other defects should be carefully evaluated, such as decay on the tension side of the tree or if the roots are undermined such as those above a road or cut bank.

Figure: a) Cracks in the soil around leaning trees indicate that such trees have a high-failure probability. b) Old leans with righted or corrected tops have low-failure probability.



Multiple Defects: Independent and Compounding Tree Defects

When trees have multiple defects, you will need to determine if the defects are independent of each other or interconnected.

Independent defects have no effect on each other; the risk of tree failure is generally equal to that of the most serious single defect.

Compounding defects are when multiple defects work in synergy, making the likelihood of tree failure greater than that of the tree's most serious single defect.

- Compounding defects require extra scrutiny and a higher level of caution.

A common example of a tree with multiple compounding defects is a leaning tree with basal decay or root rot.

- The leaning tree with basal decay or root rot is much more likely to fail than a comparable tree that is either not leaning or does not have root rot or butt decay.

The defects need to be evaluated together with increased emphasis on how those defects interact and increase the risk of stem failure.

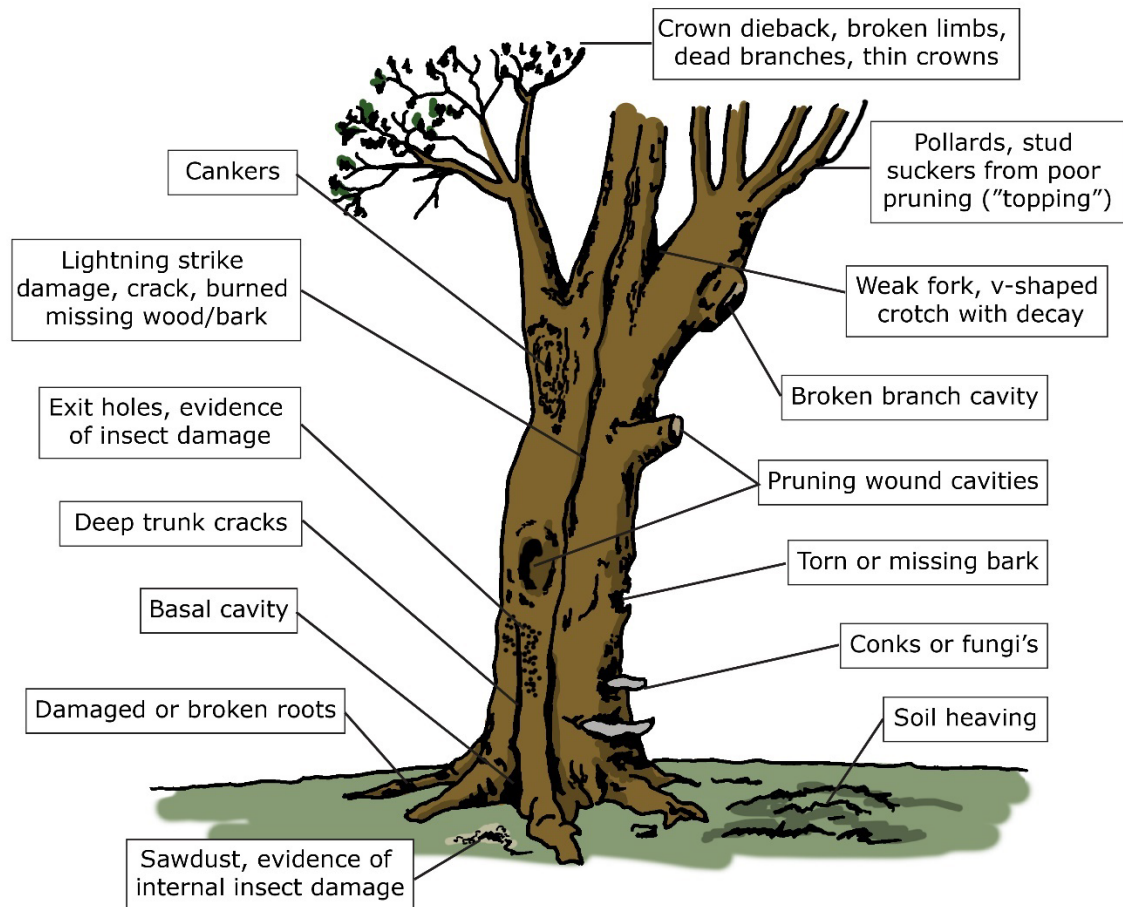

Insect-caused Damage

- Be sure to consult local experts for specific regional insects and their effects on forest health.
- Bark beetles commonly cause individual and stand level mortality when populations are high. Most conifer species have a bark beetle associate. Douglas-fir beetle is common in Douglas-fir, fir engraver is common in the true fir species, spruce beetle is common in Engelmann spruce, mountain pine beetle is common in all pine species, western pine beetle is in ponderosa pine, and pine engraver often kills small ponderosa pines or tops of ponderosa.
- Some species of bark beetles frequently attack trees that are stressed from root disease, defoliation, or drought, such as fir engraver beetles in grand and white fir or Douglas-fir beetle in root disease pockets.
 - Symptoms of bark beetle attack are boring dust, pitch streams, galleries under the bark, fading, or red crowns, dead tops, or group mortality. In contrast to root disease centers, bark beetle mortality often only happens over a brief time period and trees look to have died all at once.
- Wood borers typically come in after bark beetles, with a few exceptions.

- Bark beetles and wood borers introduce sap rot fungi when they attack the tree starting the decay process.
- Emerald ash borer is now an issue in the Eastern region. It is causing structural damage and decreasing the integrity of ash treetops initially. Secondly the structural damage moves down to the main stem.
 - Wood fiber may look healthy but is structurally compromised.
- Carpenter ants and termites can severely weaken trees that are already decayed.
- Defoliating insects such as the western spruce budworm and the Douglas-fir tussock moth can kill tops or entire trees.

Changing Forest Conditions

Drought and insect infestations are dramatically changing the forest landscape. Fire seasons are months longer than a few decades ago leaving forests severely damaged and weakened. Hurricanes, tornados, and derechos (Midwest wind events) can create numerous tree hazards. Conditions and dangers will vary by location, aspects, and within individual stands. Fire-damaged trees will be covered in Chapter 9.

“Remember that a green tree is not always safe, and a dead tree is not always in danger of imminent failure.”-Randy Anderson

For a list of local and regional specific information, visit: <https://www.nwcg.gov/committees/hazard-tree-and-tree-felling-subcommittee>.

Chapter 5 – Chainsaw Components, Maintenance, and Repairs

Equipment

Standard

- Sawyers identify components of a chainsaw and their purpose as described in the manufacture's recommendation and owner's manual.
- Sawyers will identify the different types of saw chain and the components of the saw chain and guide bar.
- Sawyers will have proper wedge type and quantity as well as an axe or wedge-driving tool of sufficient size and weight available during chainsaw operations.
- Fuel and oil containers must comply with current Department of Transportation (DOT) and OSHA Standards.

Narrative

Parts of a Chainsaw

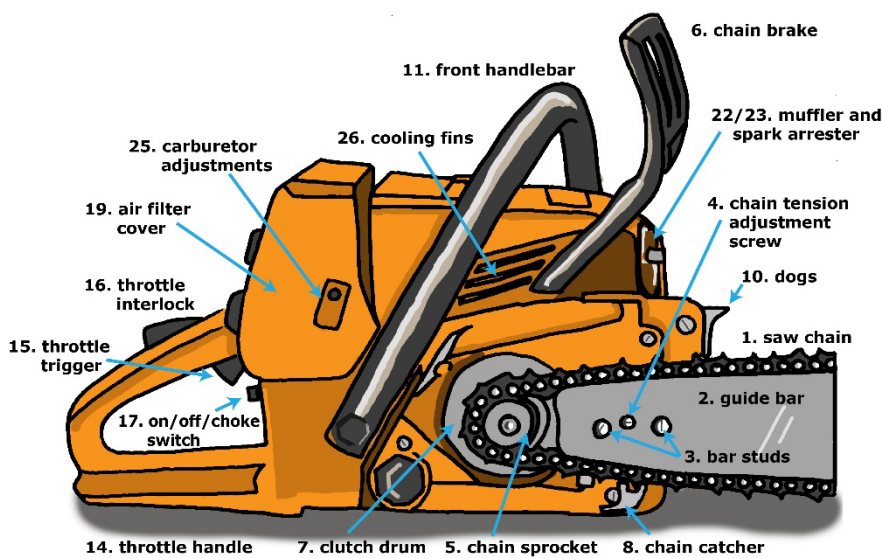

1. Saw chain.
2. Guide bar – guides chain around bar.
3. Bar studs – holds bar and chain sprocket cover in place.
4. Front and side chain tensioner – moves guide bar to maintain proper chain tension.
5. Chain sprocket – notched wheel that drives the saw chain.
6. Chain brake – stops the saw chain if it is activated by the sawyer's hand or by inertia during kickback.

7. Clutch – couples the engine to the chain sprocket when the engine is accelerated above idle speed.
8. Chain catcher – helps reduce the risk of the saw chain contacting the sawyer if the chain breaks or if the chain is thrown off the bar.
9. Starter grip – a rubber or plastic handle attached to the starter pull rope.
10. Bumper spikes (dogs) – holds the saw steady against wood.
11. Handlebar – used to hold the front of the saw.
12. Hand guard – activates the chain brake and prevents the sawyer's hand from contacting the chain.
13. Gunning marks – used to determine the planned direction of the tree's fall, based on the undercut.
14. Throttle handle – used to hold the rear of the saw.

15. Throttle trigger – controls the speed of the engine.
16. Throttle interlock – prevents the throttle from being activated unless it is depressed.
17. On/off switch – turns the saw on and off.
18. Choke – used for starting a cold saw.
19. Air filter cover – holds the air filter in place and covers the carburetor.
20. Air filter – prevents dirt, dust, and sawdust from entering the carburetor.
21. Oil and fuel caps – seal the oil and fuel tanks.
22. Muffler – reduces exhaust noise.
23. Spark arrester – prevents hot sparks from leaving the muffler.
24. Spark plug – ignites fuel in the power head.
25. Carburetor adjustments – used to adjust carburetor.

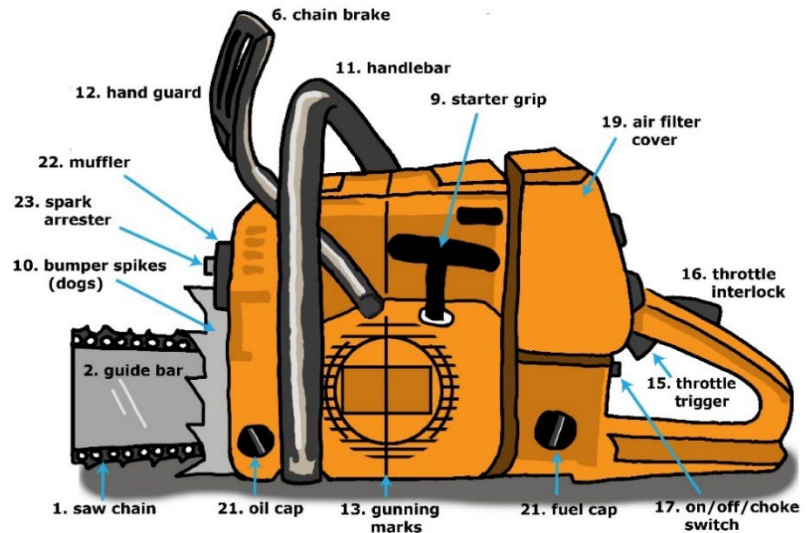

Additional Equipment

- Chain file with handle and guard, round files, file guide, and raker gauge.
- Falling ax – recommended two and half to five-pound head in good condition.
- Wedges – single-taper for falling and double-taper for bucking.
- Plumb bob – could be a bar nut or spark plug tied to a string.
- Spare parts – for chain, bar, and misc. include bar nuts, sprocket, e clips etc.
- Srench – chainsaw bar wrench/spanner wrench.
- Filters – spare air and fuel filters.
- Fuel – must be in approved fuel containers that comply with *NWCG Standards for Transporting Fuel*, PMS 442, <https://www.nwcg.gov/publications/442>.

Recommended Equipment

- Full-wrap handlebar or ¾ wrap handlebar for felling operations.
- Whistle or air horn.
- Tuning screwdriver.
- Tachometer.

Chain Components

Saw chain is made up of several parts that work together and must be maintained properly for maximum performance and safety.

The cutter is the part of the saw chain that does the cutting. The saw chain has left- and right-hand cutters so that the saw chain will cut evenly through the wood. The depth gauge or raker determines the depth of the cut.

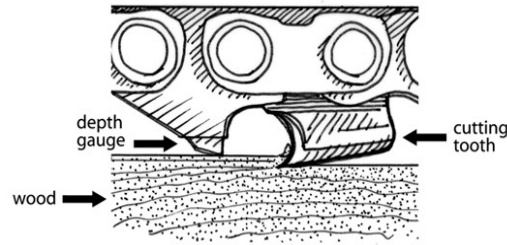
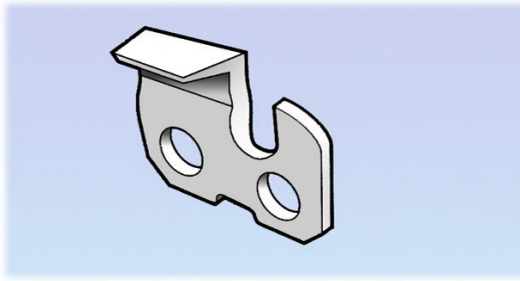

The cutters remove chips from the wood. In this process the top plate cutting edge lifts the chip off the bottom of the cut while the side plate cutting edge separates the chip from the wall of the cut. The depth gauge setting determines the height at which the cutter enters the wood and thus the thickness of the chip removed. The depth gauge setting is the difference between the top of the depth gauge and the top plate.

Parts of the Chain

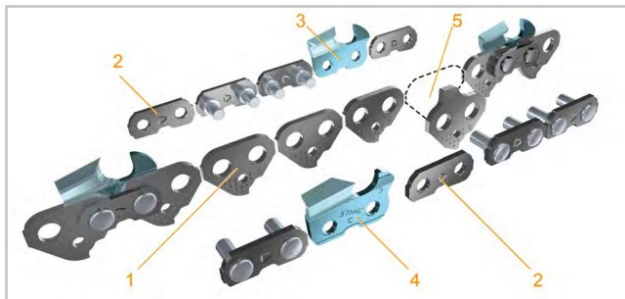

Drive link – fits in the bar groove so the bar can guide the chain around to the chain sprocket so the power head can drive the chain.

1. Tie strap – holds the chain together.
2. Left-hand cutter – cuts the wood.
3. Right-hand cutter – cuts the wood.
4. Humped drive link – low-kickback feature not found on all chains.

Types of Chain

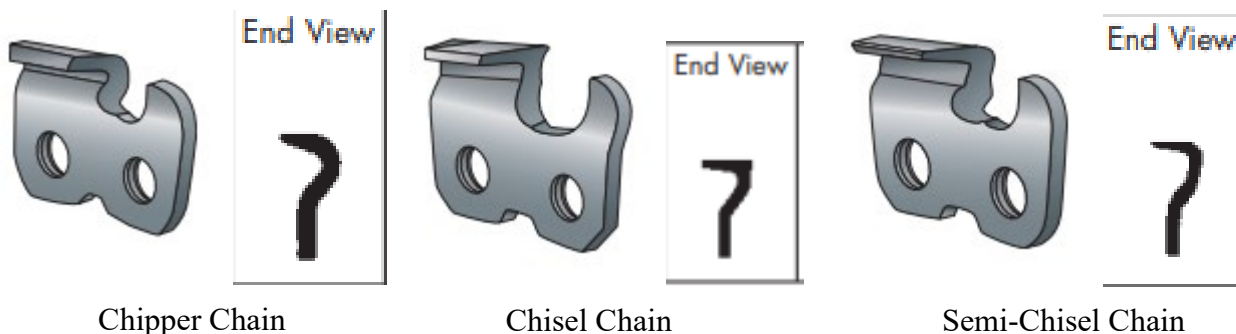

- Chipper chain is the most versatile cutter type and the easiest to file. It will tolerate dirt and dust better than chisel chains. Chipper chain is typically used for brushing, limbing, and felling smaller diameter trees.

- Chisel chain is the most aggressive cutter type. It is designed for production timber felling and should be used only by experienced sawyers. Square-ground chisel chain requires a file that fits the square shape of the cutting edge and is more difficult to file than other types of chain. Chisel chain dulls very quickly when exposed to dirt or dust. It is not recommended for brushing or limbing because of the potential for kickback.
- Semi-chisel chain is a less aggressive cutter type than chisel chain and is more tolerant of dirt and dust and stays sharp longer. Semi-chisel is good for wildland fire timber felling.

Cutter Sequences

■ CHAIN CUTTER-SEQUENCE TERMS

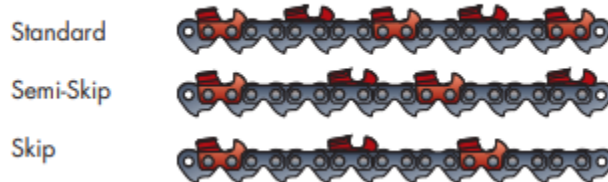

- Standard – left-hand cutter, tie strap, right-hand cutter, tie strap, left-hand cutter, tie strap, right-hand cutter for the length of the chain. Standard sequence chains cut the fastest and the smoothest and are often used on shorter bar lengths less than 24 inches for short cuts such as limbing and small diameter tree falling.
- Semi-skip – left-hand cutter, two tie straps, right-hand cutter, one tie strap, left-hand cutter, two tie straps, right-hand cutter, one tie strap, left-hand cutter for the length of the chain. Semi-skip chain is a compromise between standard and full skip and works well for general use.
- Skip or full skip – left-hand cutter, two tie straps, right-hand cutter, two tie straps for the length of the chain. Full skip chains work well on longer bars greater than 34 inches for large diameter trees so the greater space between the cutters can transport more wood chips to be deposited outside of the kerf.

Chain Measurements

Pitch, gauge, and the number of drive links all must be compatible between the bar and chain. Chainsaw bars typically have each required measurement stamped on them.

- Pitch – is the measurement between any three consecutive drive rivets divided by two (3/8" is often referred to as .375" and 1/4" as .250"). Pitch is also considered the size of the chain. The larger the pitch the bigger the chain.
- Gauge – is the measured thickness of the drive links.
- Drive lengths – number of drive links, not cutters, or tie straps.

Required chain measurements are stamped on the powerhead end of each bar.

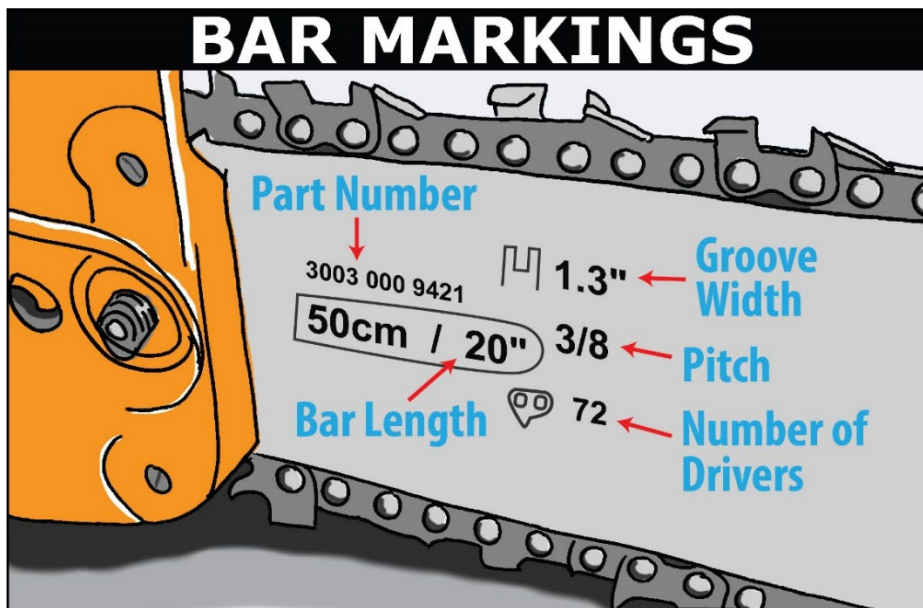

1. Part number
2. Cutting length
3. Groove width/drive link guage
4. Number of drive links
5. Chain Pitch

Chain Tension

A properly tensioned chain fits snugly against the underside of the bar and with the chain brake disengaged, it must still be possible to pull the chain along the bar by hand. Tension that is set too tight can damage the bar and chain. Incorrect chain tension is the single largest contributor to bar and chain problems.

To adjust chain tension:

1. Saw must be off.
2. Gloves must be on.
3. Loosen the bar nuts.
4. Pull the tip of the bar up and adjust tension screw until tie straps and cutters just touch the bottom of the bar.
5. Still holding the tip up, tighten the rear bar nut, then the front bar nut.
6. The chain should feel snug but pull freely.

Axes and Pounding Tools

Axes and pounding tools are used to remove bark from trees and to drive wedges during felling and bucking operations. Their weight varies, three to five pounds is average.

- The handle should be smooth and free of cracks and the head should be securely attached.
- A Pulaski should never be used to drive wedges or in place of a wedge.

Wedges

When properly placed, wedges help keep the tree from pinching your chainsaw bar and helps the tree to fall in the direction of the notch cut. Wedging also increase directional felling options against a tree's primary lean.

The two basic types of wedges used in sawing are single- and double-taper. Sizes typically range from 5.5 to 12.

- Single-taper wedges are simple inclined planes designed to provide lift during tree felling. As the wedge is driven into the backcut, the tree hinges on the hinge wood, redistributing the tree's weight.
- Double-taper wedges are designed to reduce bind. They taper equally on both sides from the centerline, forcing the wood to move equally in both directions. They perform best when used in bucking to prevent the kerf from closing, which would cause the guide bar to bind.

Figure: a) Single-Taper b) Double-Taper



Maintenance

Standards

- Sawyers will understand how to properly sharpen and maintain the saw chain and guide bar in the field.

Sawyers know the importance of routine maintenance and how often it needs to be completed as described in the manufacture's recommendation and owner's manual.

Narrative

Chain Filing

A dull chain forces a sawyer to work harder contributing to sawyer fatigue and increases the risk of kickback, accident, and injury. Three angles illustrated below must be maintained when filing.

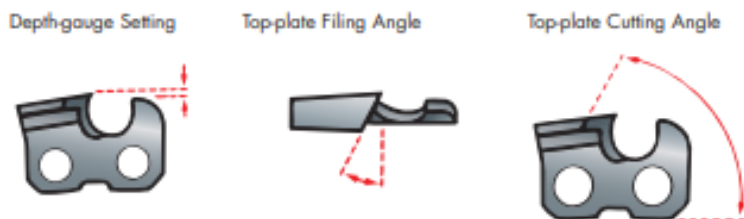

Four Methods to Sharpen Chain:

1. File with a jig – the recommended method for beginner sawyers and to occasionally correct variation in filed angles. File jigs are relatively easy to use and helpful to correct improperly filed chains.
2. File guide – sharpening guides are an effective way to improve sharpening with a file only. Maintain the correct top plate angle by keeping the filing angle parallel with the chain.
3. File Only – after learning the correct way to sharpen with jigs sharpening free-hand out in the field offers the most convenience.
4. Grinder – an electric grinder can quickly sharpen chains that have been damaged from rocks, debris, or incorrect filing.

Be sure to select a file that is the proper diameter for the chain.

Code digit on depth gauge	Alternative marking on depth gauge	Chain pitch	Round file diameter
1	¼	1/4”	4.0 mm
2	325	.325”	4.8 mm
3	3/8	3/8”	5.2 mm
4	404	.404”	5.5 mm

Basic Steps when Filing

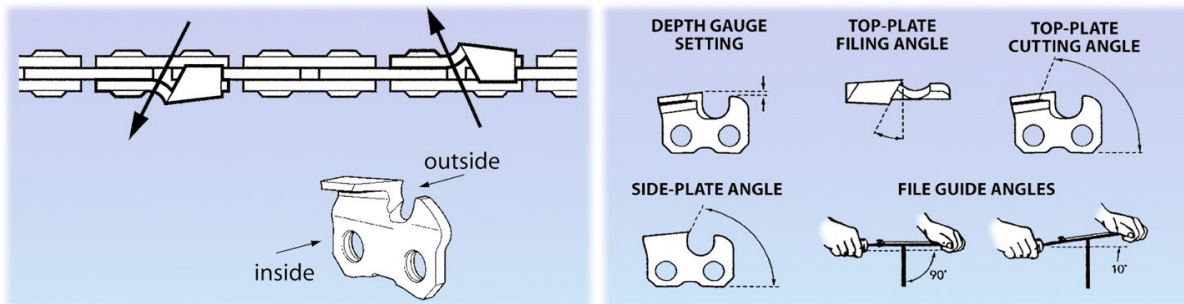

- Be sure that the chain is tensioned properly.
- Begin with the cutter that is the most damaged or the most worn and count the number of strokes it takes to file out all irregularities. Then sharpen all other cutters with the same amount of file strokes. Hold the file handle firmly with one hand and guide the file with the other hand across the cutter on the forward stroke from inside to outside.

- Be sure that $\frac{1}{4}$ of file is above the top plate to ensure the gullet is properly filed.

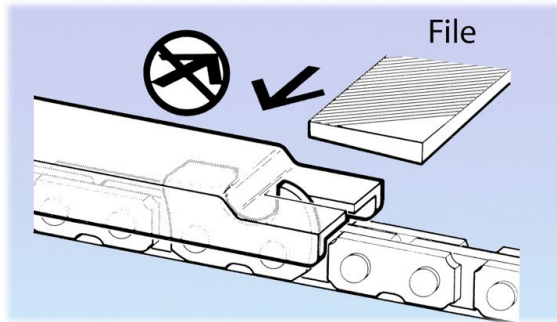

- Set depth gauges by using a depth gauge tool with the correct built-in setting for the chain. Place the tool on top of the chain so one depth gauge protrudes through the slot in the tool. If the depth gauge extends above the slot, use a flat file to file the depth gauge level with the top of the tool. Never file a depth gauge lower than the top of the tool.

Crooked saw cuts are typically due to improper filing. Many sawyers will favor one side resulting in different angles on the right and left cutters.

A clean bar in good condition guides the chain through a straight and true cut. Because the bar is softer metal, it wears more than the chain. Generally, one rail will wear more than the other, causing the saw to cut at an angle if the bar and the chain are not maintained properly.

Guide Bar Maintenance

- Clean the bar after filing the chain because the filings act as an abrasive, increasing wear. Bar grooves with debris will prevent the chain and bar from proper lubrication with bar oil. If properly cleaned and adjusted, a full tank of gas will run dry before the oil tank is empty.
- Rotate the bar each day.
- Rails should be inspected daily to prevent premature wearing of the bar and chain. If cutting problems occur including thrown chains inspect for the following.
 - Rails are worn down and the groove is shallow. If the tie straps do not touch the rails, replace the bar.
 - The outside edges of the rails develop wire edges. Use a flat file to remove them.
 - The rail is worn low on one side. This causes the chain to cut at an angle. The bar will have to be ground on a specialized bar grinder.
 - Blue discoloration is caused by a lack of lubrication, poor cutting methods that push the drive links to the side, a chain that is too tight, or a dull, or improperly filed chain.
 - The bar shows excessive wear only behind the sprocket-on-sprocket nose, caused by heavy use near the nose of the bar such as limbing or by a chain that is too loose. You can reduce this wear by periodically turning the bar over.
 - The bar is bent. This can be caused by improper cutting techniques, getting the saw pinched or bound in the cut, or improper transportation. Some bars can be straightened at a shop that has the proper equipment.
 - Chain sprocket wear is normal but is also accelerated by too loose of a chain. A worn sprocket can cause additional wear to both the chain and guide bar. Replace when worn beyond .5mm.

- Rim sprockets are frequently overlooked but should be checked regularly and can be checked by either measuring or looking at the built-in wear guide.
- One bar typically lasts for about four chains and two sprockets.

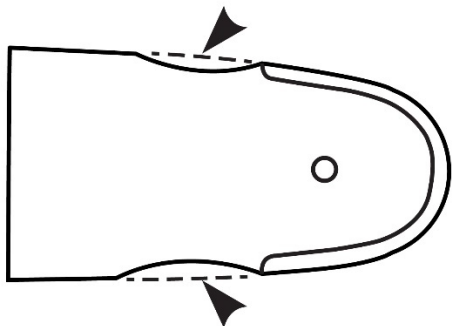
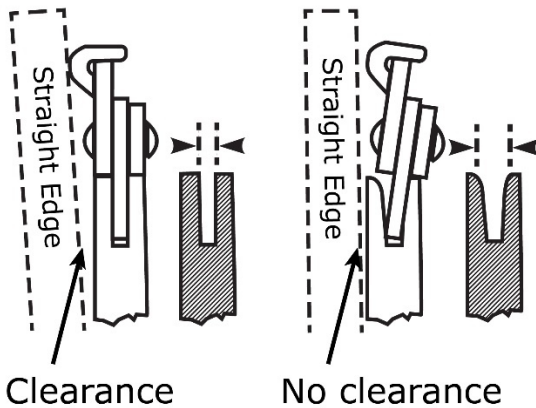
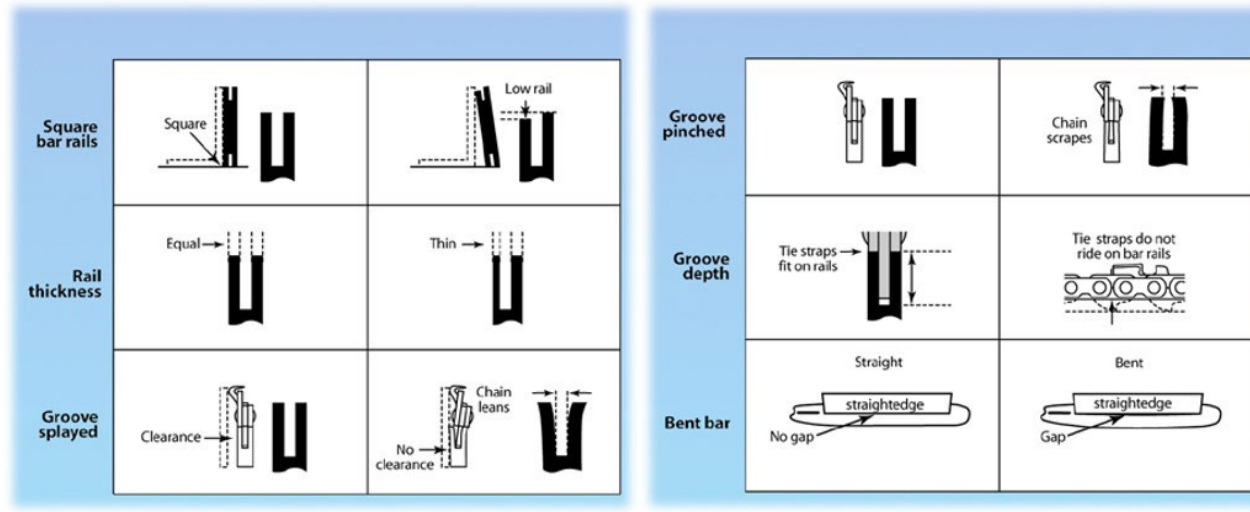

Suggested Saw Maintenance Guidelines

Daily Field Maintenance

- Fill fuel and bar oil.
- Sharpen chain using file guide.
- Use depth gauge tool to check depth gauge.
- Inspect the wear of chain, use indicators on driver.
- Remove side cover plate and clean all built up debris with scotch and brush.
- Clean bar grooves and chain oil hole on bar.
- Inspect bar for wear and burs and file if needed.
- Grease tip on bars if applicable, many bars do not need greased.
- Flip the bar.
- Check drive sprocket for wear using sprocket tool.
- Adjust to the choke position and then clean air filter. After cleaned, hold to light, and look through the filter from the inside looking out. Replace if you cannot see through it.
- Report any damage.
- Record tanks ran at the end of every shift.
- Record any parts replaced.
- Store saw with switch in STOP position.

Shop Maintenance when Returning to Station.

- Ensure all field maintenance is completed.
- Inspect anti-vibration mounts.
- Inspect fuel filter.
- Check sparkplug for proper gap and fouling.
- Clean air filter using soap and water. Do not use compressed air on filters.
- Use compressed air to thoroughly clean out built up debris.
- Check gap between magneto and flywheel.
- Ensure spark arrestor is clean and functional.
- Examine clutch for stretched springs or springs cutting into eyehole.
- Grease crankshaft hub using high-speed lithium grease.
- Clean fins on flywheel.
- Clean fins on cylinder head.
- Replace any damaged parts.

- Tighten all spline and pan head screws.
- Report any replacement parts that need to be ordered.
- Store saw with switch in STOP position.

Chainsaw Repairs

Standards

- Sawyers can troubleshoot and resolve common chainsaw mechanical problems.

Narrative

Engine Troubleshooting

Chainsaw problems can be narrowed down to fuel, air, or spark issues.

Check Fuel

- Fuel Mix.
- Fuel Filter – ideally having a spare fuel filter in your pack.
- Fuel Line – Check the fuel line to make sure it is not cracked or broken.

Check Air Flow

- The air filter on a chainsaw removes airborne contaminants from entering the chainsaw combustion chamber. When the air filter becomes clogged, the amount of air able to reach the combustion chamber drastically reduces. This can result in poor performance, sputtering, and failure to start.
- Check that the muffler and spark arrestor screen are clean. Debris buildup could restrict exhaust flow.
- Check all hoses and gaskets are secure which could cause leaks within the system.

Check Spark

- Remove the spark plug from the cylinder and attach the spark plug wire to it.
- Touch the spark plugs electrode tip to a metal surface on the engine and pull the starter cord.
- If you can see sparks, then your spark plug is working.

If you do not see a spark, check the spark plug electrode for carbon buildup, damage or wear, and correct gap spacing. Carrying a spare spark plug is advisable in the field.



The color of the spark plug's porcelain tip can indicate how the mixture is burning. A white colored plug shows a lean mixture, where a dark plug shows a rich mixture. A light brown color is optimal. Inspect the plug for running condition after jetting changes and evaluating the engine performance by ear and feel.

Checking for Compression Problems

If your chainsaw is not starting when you pull the starter rope, and you have checked the above, there may be a problem with the compression.

Compression is generated by the engine via the crankcase and the combustion chamber.

- When compression is too low, you may experience decreased power or complete shutdown because the engine is not able to hold enough pressure in the cylinder to run efficiently.

- A simple way to check for low compression is to place the chainsaw on the ground and use the starter rope to lift it.
- Good compression will prevent the rope from pulling out.
- You should be able to carefully lift the weight of the chainsaw by the starting cord.
- If you do notice the rope slowly extending, then the chainsaw compression is most likely low and needs checking more precisely.

The most common places for an air leak to occur are on the crank shaft seals. Damage to the piston or the piston rings may also be the cause of the problem. Piston rings contain cycle pressures, ensuring the force from combustion is spent pushing the piston down on the power stroke. If there is a leak, cycle pressure can leak into the crankcase, resulting in a lack of power or the engine may not start at all.

- The following reference provides information about carburetors:
<https://www.cyclepedia.com/manuals/online/free/fuel-system/carit-buretor-jetting/>.
- If you do not feel comfortable repairing your chainsaw yourself, bring it to a qualified repair shop.

It is highly recommended that inexperienced or beginner sawyers do not attempt to tune saws.

Tuning

Both variations in fuel and changes in elevation may require periodic carburetor tuning. It is recommended to tune only with the aid of a tachometer. A saw that is difficult to tune may be an indicator of other problems such as an air leak in the crank case or bushings, damaged, or dirty carburetor, bad mix, or bad gas. Before tuning identify your specific saw's, recommended factory setting for high and idle revolutions per minute (RPM).

Basic Tuning with a Tachometer

- Make sure air cleaner is clean and saw has at least ½ tank of fuel.
- Start saw and let it idle for at least five minutes to warm up.
- Set carburetor screws to factory settings, typically turn H, and L screws clockwise all the way and out one full turn counterclockwise. Exact settings are saw specific, so be sure to follow manufacture's settings.
- Using a tachometer set Low idle speed to 2,500. Never attempt to tune a saw by ear.
- Set the engine speed to 3,300 RPM with the LA (low speed air adjustment) idle screw. The saw should idle smoothly without any chain spin. Reset the Low idle speed if necessary.
- Adjust High screw to about 500 RPM less than the manufacturers recommended maximum RPMs. Fine tune L and LA screws if necessary.



Importance of High Octane and Ethanol-Free Fuel

Low octane fuel combusts faster than high octane fuel which in a small engine causes inefficiency and wear. Saw manufactures recommend 89 octane fuels but 91 premium grade is highly recommended and more than pays for itself.

Ethanol easily attracts and mixes with water, so any moisture in the air can be absorbed by the ethanol gasoline blend.

- If enough water is absorbed, the ethanol, and water will settle out of the gasoline blend.
- The resulting ethanol and water mixture is heavier than the gasoline and settles to the bottom of the equipment's tank or your storage can, leaving a layer of gasoline floating on top.
- With the ethanol separated from the gasoline, the layer of gasoline now has a lower octane level than the original ethanol gasoline blend.
- This can result in hard starting, unsafe high idle speeds, stalling, and can ultimately lead to engine damage or fuel system failure and costly repairs.

The solvent properties of ethanol can also dissolve varnish and gum deposits that have previously formed inside fuel storage cans, fuel tanks, or the equipment's fuel system.

Chapter 6 – Basic Saw Operations and Handling

Starting a Chainsaw

Standards:

- Sawyers will use correct starting procedures as described by OSHA.

Narrative:

OSHA's Safe Operation of a Chainsaw, 29CFR 1910.266(e). (1) and (e). (2) discusses practices required for safe operation before starting the saw and while running the saw. For more information, please refer to Safe Operation of a Chainsaw, <https://www.osha.gov/etools/logging>.

Do not drop start a chainsaw. This is the most dangerous starting method because you have no control of the saw.

Starting the Chainsaw on the Ground

- Set the chain brake with the choke on. Avoid engaging the throttle lock or the fast-idle position of the on/off switch.
- Place the saw on firm ground. Make sure that the saw's bar and chain do not contact anything.
- Put your foot in the rear handle and keep a firm grip on the front handle with your hand.
- Pull the starter handle with your other hand. Repeat until the engine fires. Shut choke off once saw fires.
- Accelerate so that the engine idles and then release the chain brake.

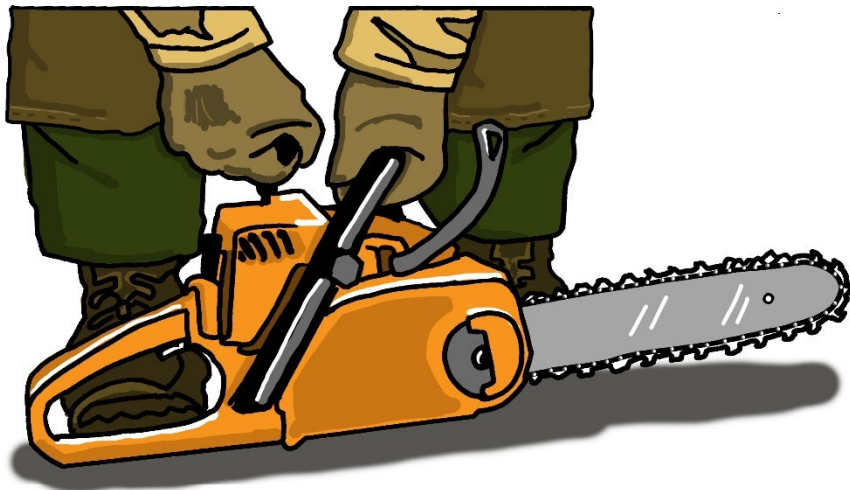

Starting the Chainsaw Standing Up

- Set the chain brake.
- Place the rear handle between your thighs and behind your knees. Hold the front handle firmly with your other hand.
- Slowly pull on the starter rope until the starting mechanism engages and finish a quick pull to start the saw.
- Pull the starter handle with your other hand. Repeat until the engine fires.

- Make sure that the saw's bar and chain do not contact anything.
- Accelerate so that the engine idles and then release the chain brake.



Transporting a Chainsaw

Standards

- Sawyers will use correct techniques for carrying the chainsaw.

Narrative

Walking with a Chainsaw

- When carrying the saw for short distances, set the chain brake.
- When carrying the saw farther than from tree to tree, or in hazardous conditions such as slippery surfaces or heavy underbrush, shut the saw off and carry in a way that prevents the chain, muffler, and dogs from contacting your body.
- When carrying the saw on your shoulder, take extra care because of the sharpness of the chain and dogs. A long-sleeved shirt, gloves, and a shoulder pad should be worn. The bar, chain, and dogs should be covered, preferably with a bar and chain sheath. Avoid direct skin contact with the muffler and power head. Chainsaw chaps can also be used to cover the dogs.

Transporting Chainsaws in a Vehicle

- Keep the bar and chain covered with a chain guard or chaps.

- Properly secure the chainsaw to prevent it from being damaged and to prevent fuel from spilling.
- Never transport a chainsaw or fuel in a vehicle’s passenger compartment.

Safe Handling

Standards

- Sawyers will use correct techniques and body position for operating the chainsaw.
- Sawyers understand reactive forces and their causes including bind and kickback.
- Sawyers understand boring technique and when it is applicable.

Narrative

Handling Techniques and Body Position

The sawyer’s thumb and forefinger should always be wrapped completely around the handlebar, no matter how the saw is turned. The thumb and fingers are essential for maintaining control of the chainsaw, especially during a kickback.

Full-wrap handlebars are designed to be used by both the left and the right hand allowing for more cutting options which can reduce exposure from walking around a tree. Cutting with the bottom of the bar increases efficiency and decreases fatigue.

- Never operate a chainsaw with one hand as you will greatly increase exposure from kickback.
- Never operate a chainsaw with the throttle lock engaged which could lead to a loss of control.

Maintain balance between both feet and equally distribute the saw weight throughout your body to allow for safer response to kickback.

- Never cut while balanced only on one foot.

Figure: Cutting Forces in different bar locations

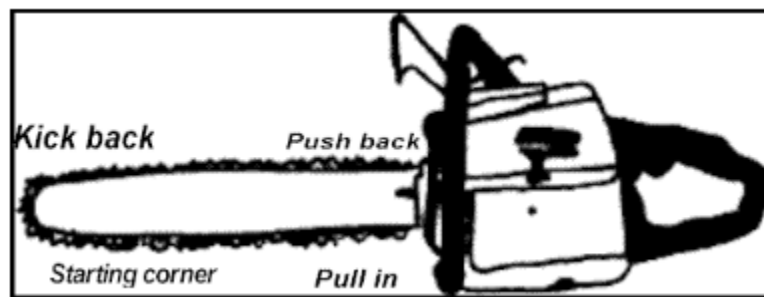

Kickback

Kickback is the sudden, upward motion of a chainsaw’s guide bar and is one of the most common causes of chainsaw accidents. If proper cutting techniques are not followed, the lightning-fast kickback of a chainsaw can be very dangerous and may result in serious injury.

Two circumstances that can cause kickback when using a chainsaw.

- The first occurs when the moving chain at the tip or the nose of the guide bar strikes an object.
- The second situation is when the wood closes in, pinching the saw chain in the middle of the cut.

Many factors determine the severity of the kickback.

- Chain speed.
- Angle of chain contact.
- Condition of the chain.
- Speed at which the bar contacts the object.

Kickback can occur while felling, limbing, bucking, or brushing.

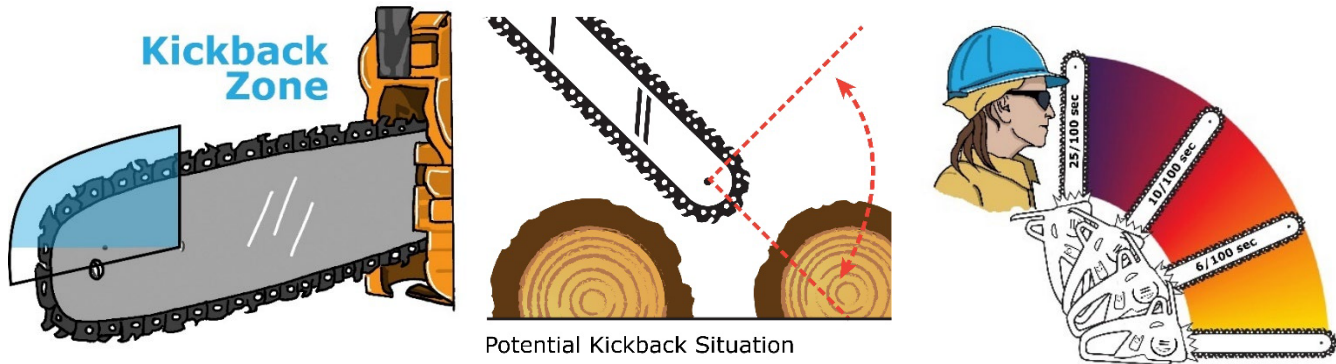

Ways to Avoid Kickback Injury

- Hold the saw with both hands, securely gripping the handle and the handlebar between your thumb and forefinger.
- Stand to the side of the kickback arc while cutting.
- Be aware of the location of the bar's nose and only cut one piece of material at a time.
- Never overreach or cut with the power head higher than your shoulder.
- Pull the saw smoothly out of the cuts, watch for any movement that may pinch the chain.
- Use caution when entering a partially completed cut.
- Use low-kickback chain that is properly sharpened and tensioned.

Pushback

Pushback occurs when the chain on the top of the bar is suddenly stopped by contacting another object or by being pinched. The chain drives the saw straight back toward the sawyer.

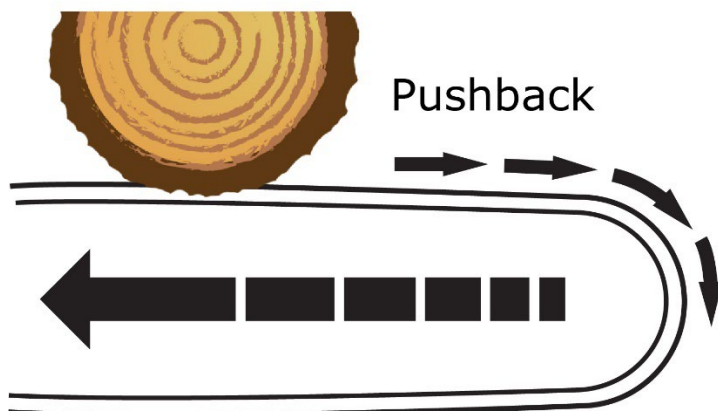

Ways to Avoid Pushback

- Only cut with the top of the bar when necessary.
- Watch the cut and the log for any movement that may pinch the top of the bar.
- Do not twist the bar when removing it from a boring cut or under buck.

Boring

Boring cuts can be used in bucking operations, evaluating wood fibers during tree size up, and in certain backcut situations.

Whenever boring, hold the saw firmly and place yourself in a location outside the kickback arc.

- Only use the bottom half of the bar tip when beginning a bore.
- Engage the material with half to full throttle before cutting into the wood surface.
- Once the tip has begun to cut into the wood fully, maintain full throttle and continuous pressure while holding the saw steady and plunge the bar in perpendicular to the tree.
- If the chainsaw begins to jump or kickback in the cut, twist the handle of the saw slightly while continuing to maintain continuous pressure in the desired orientation.

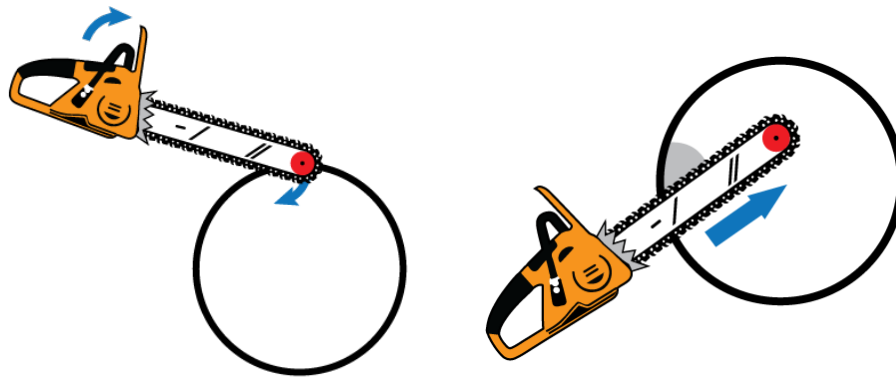

Sawyer/Swamper Teams

Standard

- Prior to saw operations sawyer/swamper teams will establish responsibilities and verbal and nonverbal communications.
- Sawyer responsibilities must be identified and implemented prior to chainsaw operations.
- Swamper responsibilities must be identified and implemented prior to chainsaw operations.

Narrative

Sawyers often operate chainsaws very close to swampers. This can present some safety considerations. Swampers should wear the same PPE as the sawyer. The sawyer and the swamper have a shared responsibility to the safety of each other and maintaining cutting area control. This operation requires sawyers and swampers to be constantly communicating and adhering to pre-established protocols.

Sawyer Responsibilities

- Discuss the brushing, limbing, and bucking plan with the swamper.
- Maintain awareness of the location and proximity of the swamper.

- Develop a process with the swamper to safely remove cut material.
- Cut material to facilitate safe and efficient removal.
- Maintain cutting area control.
- Develop a process to maintain situation awareness.

Swamper Responsibilities

- Discuss the brushing, limbing, and bucking plan with the sawyer.
- Swampers working in the cutting area within reach of the sawyer should assure the sawyer is aware of their presence.
- Do not approach unless the sawyer indicates that you can.
- Never push or pull on material while the sawyer is cutting it.
- Help to identify hazards and maintain situational awareness.
- Other crewmembers should not directly approach the sawyer but rather approach the swamper who will then get the sawyer's attention.

Chapter 7 – Brushing, Limbing, and Bucking

Cutting Area Safety

Standards

- Sawyers determine whether the tree can be limbed or bucked safely or if there are other options such as moving the fireline, equipment use, or creating no-work zones.
- Always perform a hazard analysis when entering new work areas and mitigate the hazards or establish a no-work zone.
- Sawyers will establish cutting area control.
- Sawyers coordinate to avoid working directly above or below other saw teams.
- Establish escape plan when brushing, limbing, and/or bucking.
- Cut limbs, stems, and stobs flush to the ground or bole to minimize tripping and impalement hazards.
- Sawyers recognize and mitigate spring poles during the cutting operation.

Narrative

Always inspect work area for widow makers and overhead hazards. Mitigate the hazards or change locations.

Figure: Hazard trees and leaners need to be removed or change locations.



Develop a work plan with others in the area with work area boundaries and swamper-sawyer safety protocols.

- Saw teams should never work directly below one another. Teams must coordinate with others to minimize exposure directly below one another.

Warn workers who are working in or below an active cutting area. Allow workers time to move to a safe location. Verify their safety visually and verbally.

Never approach a cutting operation from below until the sawyer has granted permission to proceed.

Establish escape paths even when brushing, limbing, and bucking. As cut material accumulates from the operation, safe footing may become more difficult. Safe egress may also become more difficult, continually identify new escape paths to minimize risk.

- Engage the chain break whenever walking between cuts and shut saw off when moving further than tree to tree.
- Cut limbs, stems, and pointed stobs need to be cut flush and within a couple inches of the ground. Do not leave pointed stems that could cause injury during a fall or be a tripping hazard.
- Spring poles are trees that are pinned under tension. Spring poles can release tremendous force when they are cut, striking the sawyer, or throwing the chainsaw back into the sawyer.
- To safely remove spring poles, start by relieving some of the tension in a controlled manner. Stand back a safe distance and make a series of shallow relief cuts about ½ inch apart on the underside of the spring pole.
- Be careful not to cut too deep and stop as soon as you detect movement, remove the saw, and begin the next cut. Four to six cuts on the underside of the spring pole should be sufficient.
- The release cut is made from the top, about one-half inch past the end of the series of cuts on the underside and on the piece that is going to fall to the ground. Be sure you are clear of the piece that will be released.



Brushing

Standards

- Sawyers determine cutting sequence to meet cutting plan.
- Sawyers understands high potential for thrown chain and kickback during brushing operations.
- Sawyer and swamper will establish best practices for clearing cut debris.
- Sawyers maintain proper footing, balance, and saw control.

Narrative

Brushing is cutting and clearing small diameter material such as brush, branches, and/or trees.

The chain is more likely to be thrown when you are working with small material. Laterally moving a saw while it is still cutting will significantly increase the chance of a thrown chain.

Operating saws close to the ground increases the chances of kickback and damage to the chain. Sawyers must watch out for rocks, dirt, and material that may cause kickback.

- Always maintain awareness of the tip of the bar.

- Check chain tension often.

Continuous brushing requires the sawyer to work in a crouched position for long periods of time possibly straining back and arm muscles.

- Rotate sawyers often in brushing situations.

Limbing

Standards

- Sawyers will determine cutting sequence to meet cutting plan.
- Sawyer and swamper establish best practices for clearing cut debris.
- Sawyers maintain proper footing, balance, and saw control.

Narrative

Limbing is the removal of branches from the bole of a fallen tree so that the tree can be bucked or cutting limbs off standing trees.

Small trees can be limbed while they are still standing which may reduce bar tip exposure and kickbacks.

- Limbs should only be removed from standing trees to a height the sawyer can safely reach, not to exceed shoulder height.
- When limbing standing trees avoid cutting or scaring the tree bole, limb just outside of the bud swell of the limb.
- Always identify escape paths and monitor the tree for movement such as rolling or dropping.

Make sure stem is severed from the stump unless it is beneficial to keep it from rolling. Begin cutting limbs on one side identifying any supporting limbs. If the tree is large enough to cause harm if it rolls or settles, consider cutting supporting limbs last or during the bucking sequence.

- Anticipate movement of a downed tree before cutting supporting limbs.
- Swamper should clear debris as limbs are cut to minimize tip exposure and kickbacks.

When cutting a heavy limb, make a small cut on the underside before the top cut to fully sever the material.

Bucking

Standards

- Sawyers determine cutting sequence to meet cutting plan.
- Sawyers identify the good and bad side of a log which is typically on the downhill side or tension side of the log.
- Sawyers understand the effects of binds and technique mitigations needed.
- Sawyer recognizes the location of tension and compression.
- Sawyers recognize, anticipate, and predict the potential movement and reaction of the cut material.

- Sawyer and swamper establish best practices for clearing cut debris.
- Sawyers maintain proper footing, balance, and saw control.

Narrative

Bind determines bucking techniques and procedures.

- Look for clues such as landforms, stumps, blow down, and other obstacles that prevent a log from lying flat creating binds.

Tension and Compression

- Tension is when wood fibers are stretched apart, and the kerf opens as a cut is made.
- Compression is when wood fibers are pushed together and the kerf closes pinching the bar.

Figure: The log is being pulled apart by tension force and pushed together by compression force. Areas of tension and compression occur on opposite sides of the log.

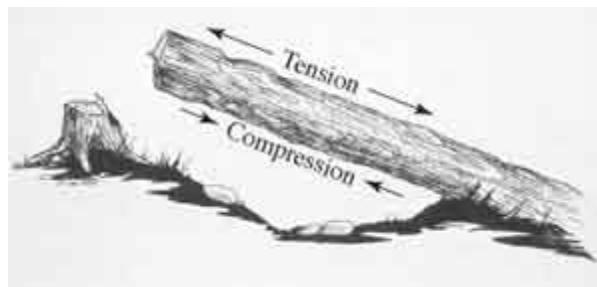

Four Main Locations of Bind

- Top bind – The tension area is on the bottom of the log with compression on top.
- Bottom bind – The tension is on the top of the log with compression on the bottom.
- Side bind – Pressure is exerted sideways on the log. The tension side is usually bowed out.
- End bind – Weight compresses the log's entire cross section.

Prior to Bucking

- Identify the Good and Bad side: Typically, in a bucking situation the bad side would be on the downhill side or tension side of the log.
- Swamp out bucking areas and escape paths.
- Inspect the log for binds, pivot points, and natural skids.
- Mitigate any spring poles bent under the log being bucked.
- Anticipate the reaction after the release cut has been completed.
- Falling or rolling root wads are unpredictable when compression is released.
- Personnel below the cutting area can be in the path of rolling logs.
- Rocks and foreign objects under the log may cause a log to roll or slide and even pivot uphill.
- Hidden limbs may roll with the log and entangle the sawyer.

Bucking Techniques

Establish good footing and anticipate movement of the tree and be ready to step away.

On large trees, begin bucking by cutting the offside first.

- This is the side the log might move to when it is cut, normally the downhill side.
- Cut straight down until you have space for a wedge.
- Observe the kerf for movement that will indicate the location of a bind.

Use the saw's bumper dogs as a pivot point when you are bucking. This technique will enhance your control of the saw and improve the saw's efficiency, while reducing fatigue.

When the offside has been cut first, the sawyer can finish stepping away from the danger.

- In most situations it is safest to buck logs from the uphill side unless the log may pivot uphill when it is bucked.

It is typically safest to start bucking at the small end of the log and work toward the butt end, removing the binds in the smaller material first.

- The exception is on a steep slope where it may be safer to begin on the upslope portion of a log to minimize exposure should the log slide or roll downhill.

When possible, remove compression before tension to minimize pinching the bar.

Various techniques can be used to control bucked sections. For example, angles can be used to prevent a section from rolling down slope.

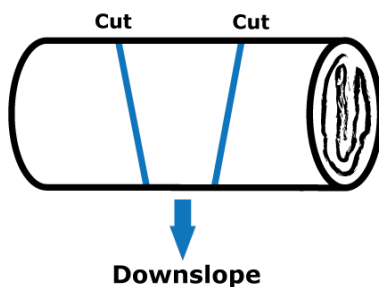

Angled cuts may allow greater clearance to move a section after bucking.

Cut pieces small enough so they are easier to control.

Roots of blow down could be forced into the sawyer's position if the roots drop or roll. If limbs are preventing the roots from shifting, consider leaving them.

Top Bind

1. Cut from top down, stopping before kerf closes and pinches bar.
2. Partially cut offside which will allow sawyer to step back when finishing cut.
3. Finish by cutting from the bottom up while stepping away from the log.

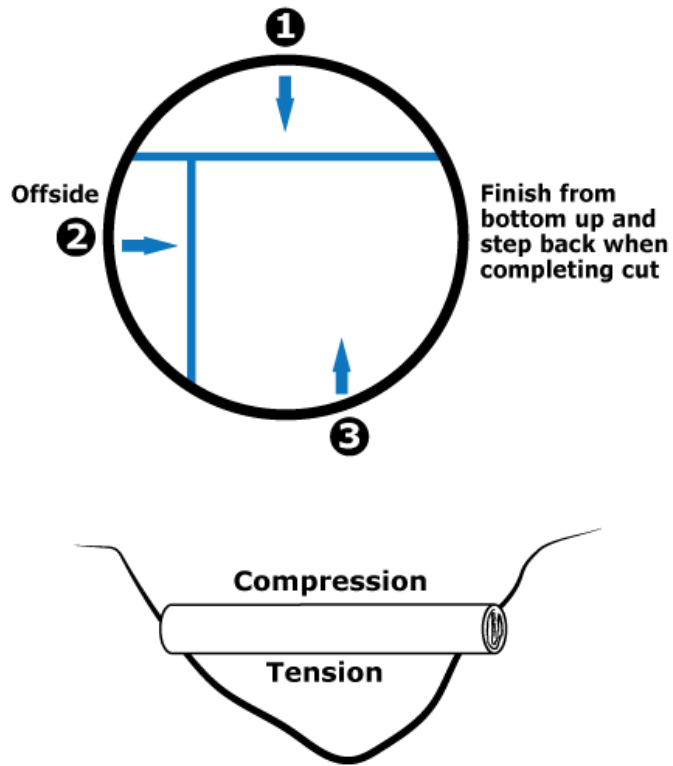

Bottom Bind

1. Cut from bottom up, stopping before kerf closes and pinches bar.
2. Partially cut offside which will allow sawyer to step back when finishing cut.
3. Finish by cutting from the top down while stepping away from the log.

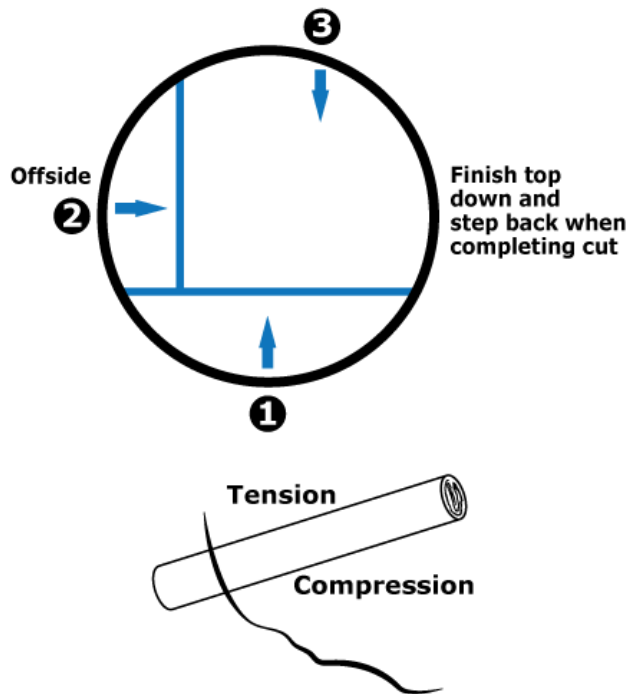

Chapter 8 – Directional Felling

Standards

- Sawyers will determine if a tree needs to be felled utilizing the risk management process or if there are other options such as moving the fireline, equipment use, or creating no-work zones.
- Sawyers will complete a procedural size up prior to engaging in felling operations.
- Sawyers understand the relationship of the ongoing size up, human factors, environmental hazards, risk, and complexity.
- Understanding that determining the complexity of a felling operation is one of the most important processes for a sawyer to understand and implement.
- Sawyers identify the good side and the bad side of the tree to be felled.
- Sawyers cut within their qualification level unless under direction of a higher qualified sawyer.
- Sawyers establish cutting area control including the need for road guards, crew spacing, and coordination with resources above and below the cutting area.
- Sawyer and swamper establish work procedures to safely work together within the cutting area and have a mutual understanding of each other's responsibilities specifically regarding felling operations.
- Sawyers utilize the correct sequence of cuts to construct a functioning hinge.
- Sawyers recognize and adjust cutting plan as needed based on wood condition and cutting sequence effectiveness.
- Sawyers will call out the backcut and direction of fall to alert others.
- After the tree falls, sawyers will reevaluate the canopy for aerial hazards before re-entering the cutting area.
- Sawyers recognize the increased complexity presented by hung trees.
- Sawyers that create hang-up during felling must reevaluate the situation utilizing a new size up, determining if the hung tree should be left if not easily freed.
- Sawyers complete stump assessments through the course of operations to evaluate and improve performance.

Narrative

Hazardous Tree Risk Refusal Practices

Every sawyer has the right to stop cutting at any point when he or she feels that their safety is compromised.

- The right to disengage exists at any point in a cutting operation, even in mid-operation.
- A sawyer that declines an operation has the responsibility to communicate their decision to their supervisor.

Supervisors and co-workers need to support those decisions. At that point there are several other options that can be considered.

- Leave the tree – Flag the hazard area around the tree and attach a note explaining the hazard. Inform supervisors, crewmembers, and adjacent crews of the hazard.
- Heavy equipment – Logging equipment can be used to safely mitigate hazard trees.
- Explosives – Request a blaster to fall a hazardous tree.
- Pull tree with a cable – A truck winch or portable winch can be used to pull a hazard tree down.
 - There must be adequate room to operate the winch, location must be free of any hazards. Also, the tree needs to be safe enough for personnel to attach the cable.
- Burn the base – Building a significant fire at the base is another option to consider if there is not a sense of urgency for the tree to be cut down.

Develop a Falling Plan

Elements of a falling plan include:

- A risk analysis based on size up (Chapter 3).
- Determine best side to complete cuts (Chapter 3).
- Sequence of cuts and location.
- Primary and secondary escape paths.
- Plan for wedging.
- Identify circumstances that may go wrong with consequences and mitigations.
- Equipment check including sharp chain, fueled saw, wedges, and axe, or pounder.
- Work Area control (Chapter 2).

Determining Lean

Many sawyers have been killed or hurt because they failed to plumb a tree as part of their size up. Understanding lean gives critical insight to the forces influencing felling. Slopes, limbs, limb anatomy, and adjacent trees can give false vertical references that a plumb bob will more accurately assess. A plumb bob is simply a weight such as a sparkplug or two bar nuts tied to a string.

Natural Lean

- Head lean is when the lean is towards the target.
- Back Lean is when the lean is away from the target.
- Side Lean is when the lean is laterally away from the target.

Other Factors Influencing Lean

- Limb weight from the location and size of limbs favoring one side or another.
- Multiple stems or hardwood canopies make natural and calculated lean detection more difficult.
- Tree sweep is when the bole curves and then straightens further up the tree.

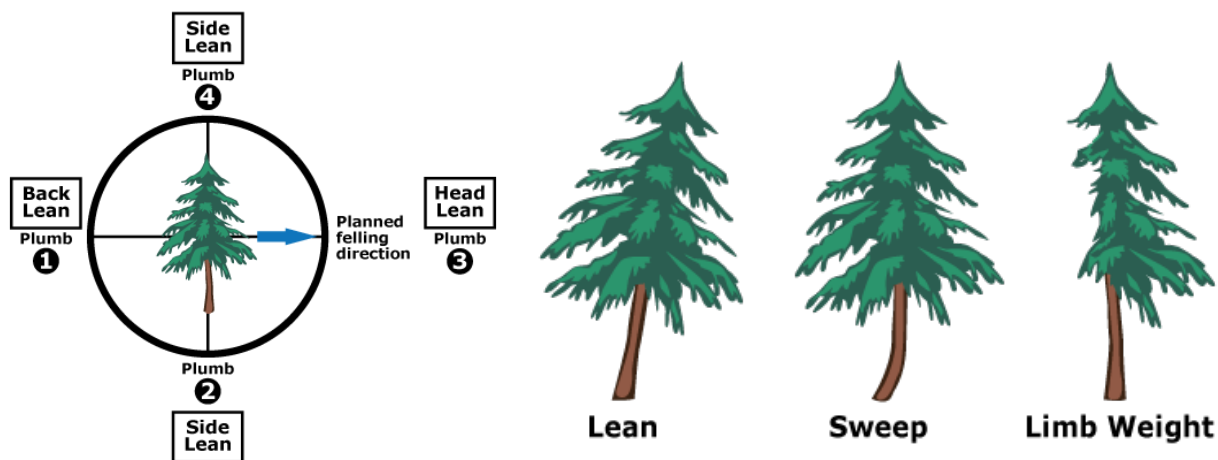

Calculated Lean

Imagine two lines drawn through a circle around a tree. The first divides the circle in half from the planned undercut (undercut will be used in place of other terms such as face cut, gunning cut, open-face cut, and Humboldt) through the backcut.

- Plumbing along the first line will determine side lean.
- The second line is through the center of the tree perpendicular to the first.
- Plumbing along the second line will determine head or back lean. Some leans may not be detected until you are at a right angle to them.

Simple leans can be determined from plumbing one side of each line, but more complex leans may need to be plumbed from all four sides of the tree.

Typically, a lean is described as the amount of feet the top of the tree is off center. Ideally trees should be plumbed from a distance of at least $\frac{1}{2}$ the trees height.

Walk out the Lay

Determine the intended target or lay.

- Look for any obstacles that could cause the tree to bounce back behind the stump or cause the butt to jump or pivot as the tree hits the ground.
- Mitigate any trees or snags that could be thrown back towards your escape paths.

Escape Path and Safety Areas

With the desired felling direction in mind, determine your escape plan by identifying relevant escape path(s) and safety area(s).

- “Before felling is started, the feller shall plan and clear a retreat path. The retreat path shall extend diagonally away from the expected felling line unless the employer demonstrates that such a retreat path poses a greater hazard than an alternate path. Once the backcut has been made the feller shall immediately move a safe distance away from the tree on the retreat path.” OSHA 1910.266(h)(2)(I).
- Identify the best side for your final cut to minimize movement from one side to the other.

Safety areas should be a distance that a sawyer can quickly get to when a tree commits to falling.

- Many accidents and fatalities have involved trees breaking in half and falling back into a planned escape route or hitting another tree that falls back.
- For this reason, a sawyer should keep an eye on the falling tree as he/she travels the escape paths.
- Make sure that tripping hazards and debris is cleared from escape paths prior to falling.

Sounding the Tree

Pounding on a tree with the flat side of an axe or pounding tool provides clues to the condition of the internal wood fibers.

- A hollow thump indicates rot which could impact hinge wood, wedging platforms, and integrity of the boles.
- Look up for falling debris after each hit.
- Be careful when pounding on snags that have weakened boles, limbs, or widow makers. Some trees may be too dangerous to safely pound on.

Boring

Boring is the best way to verify hinge and wedging platform conditions and should be considered when felling standing dead trees or trees with suspected heart rot which would alter hinge effectiveness in controlling the tree to the ground.

- Monitor the chips off the chain while boring.
- Rotten fiber will often appear as darker brown dust distinctively different from longer wood chips of sound wood.

Boring should be vertical and perpendicular to the hinge wood to reduce the impacts to the hinge and wedging platform. Be careful not to compromise the hinge wood.

- Remember to observe overhead hazards and look up often.

Figure: Do not weaken the hinge wood by boring into or across any of the hinge wood.

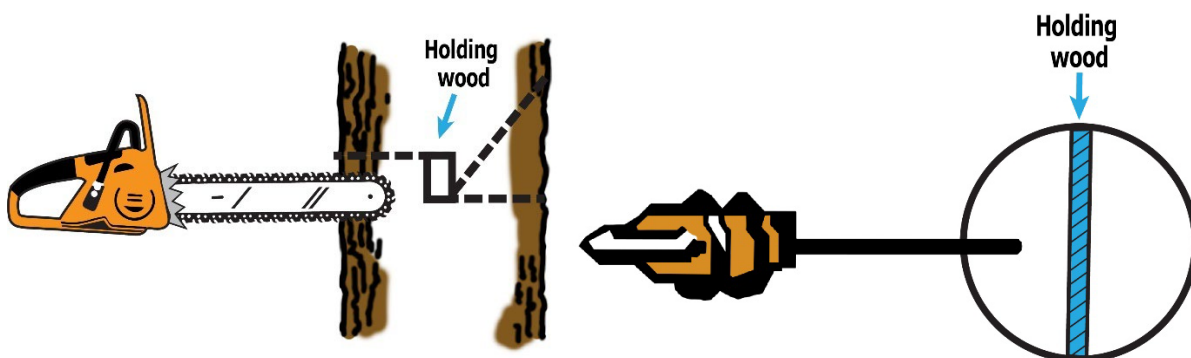

Bark Removal

For trees with bark thicker than four inches it may be helpful to remove the bark where the planned corners of the undercut will be located. This will give the sawyer a more accurate placement of the saw for each cut.

- Removing bark in the planned wedging areas may reduce sawyer exposure once the felling operation begins.

General Felling Operations

Tips for Making Level Cuts

Proper hand position on the wrap will aid in keeping the bar from rolling, resulting in a sloped cut.

- To practice a baseline level position, place a magnetic level perpendicular on the bar.
- Notice as you move your hand left and right on the wrap, the saw will roll respectively.
- Adjust your grip on the wrap until the saw becomes level.

For tip height, turn the level parallel to the bar and apply weight to your trigger hand until level.

- The hand that is on the wrap needs to stay relaxed once the kerf is established and let the saw do the work.

Types of Undercuts

There are three common undercuts to fall trees.

- Conventional Undercut
- Humboldt Undercut
- Open Undercuts

Each is comprised of three cuts.

- The first two form the undercut, formerly called pie or face, and consist of a horizontal and a sloping cut.
- The third is a backcut.

Together they form a hinge that controls the direction and fall of the tree.

Each cut offers advantages.

- Conventional Undercuts are most common as they are simple to execute and work well in most situations.
- Humboldt Undercuts allow the butt of the tree to slide off the stump closer to the ground and minimize breaking.
 - Humboldt cuts may also allow better saw control on steep slopes.
- Open Undercuts maximize felling control with a larger hinge allowing for more control as the tree falls.

The height of the undercuts should be at a comfortable level for the sawyer to frequently look up for overhead hazards and to quickly escape from the stump if needed.

- However, some cuts on steep slopes may need to be lower on the upslope side so that the downslope side can be safely cut.

Check saw fuel prior to the undercuts and before the backcut if necessary. Stopping for fuel mid-operation significantly increases exposure.

Conventional Undercut

The conventional face consists of three cuts.

- Horizontal cut, sloping cut, and backcut.

Figure: A horizontal cut and a sloping cut make up the undercut. The backcut is the third cut that falls the tree.



Horizontal Cut

Also known as the gunning cut.

- Start by facing the desired target and set the saw dogs at the desired corner location of the undercut and begin the horizontal cut.
- When completing, look down the gunning marks to align with the desired felling direction.
- This cut should be about one-third of the tree's diameter.
- It may be helpful to begin the horizontal cut by facing the target while leaning a shoulder against the tree for stability.

Sloping Cut

The sloping cut is the second of the undercut.

- The sloping cut is made at a 45-degree angle to meet the horizontal cut.
- Be careful when correcting mismatched cuts, do not create too deep of an undercut.
- It is acceptable to chop out remaining corner wood with an axe versus increasing the size of the undercut.
- These two cuts must match before proceeding to the backcut.
 - If these cuts do not match a bypass is formed.

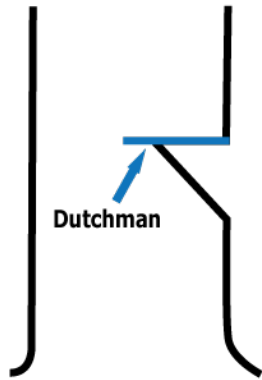

This kerf-wide cut makes the direction of the tree's fall harder to predict.

- A dutchman will close first as the tree falls prematurely severing the hinge wood and causing loss of control of the tree as it commits to the face.
- It can also cause the tree to barber chair, lifting the log off the stump and placing the sawyer at great risk.

Figure: Barber chair Tree – OSHA



- Cleaning up a dutchman creates an exposure trade off. When correcting a dutchman the undercut only needs to be functional but does not need to look perfect.
 - Make your corrections and proceed with cutting the tree down.

Figure: The sloping cut is a 45-degree angle.



Backcut

The backcut determines the hinge wood.

- Visualize a rectangle between the undercut and backcut.
- The height of the rectangle makes up the stump shot.
- The stump shot helps prevent the tree from coming back towards the sawyer after it falls.
- The width of the rectangle makes the hinge wood which helps guide the tree as it falls.
- The dimensions of the hinge wood and stump shot is proportional to tree diameter but two to four inches of hinge wood and at least two inches of stump shot is a common rule of thumb.

Figure: When setting hinge wood dimensions remember that the intent of the hinge is for the wood fiber to bend versus break to guide the tree as it falls.

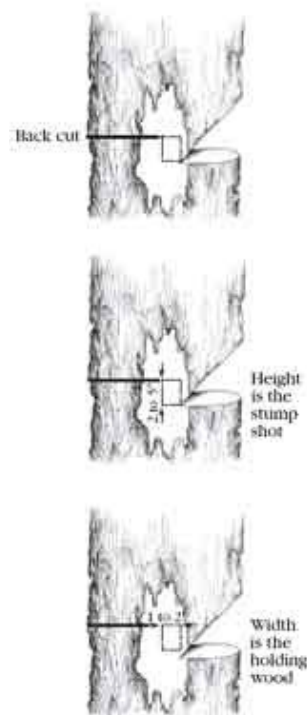

Be sure to utilize the good side of the tree to complete cuts and for a primary escape route.

- Once the undercut has been cleaned, recheck the felling direction.
- Shut off the saw and give warning shouts (example, “Backcut tree coming down!”). Listen for a reply before proceeding with the cut.
- Continually look above for possible hazards and at the kerf for movement. Line up the gunning site at the completion of the backcut.

Humboldt Undercut

A Humboldt is distinguishable with the undercut below the horizontal cut which causes the falling tree to slide off the stump at a lower point than a traditional undercut.

- Because the downward facing sloping cut allows the butt of the tree to contact the ground before the rest of the tree, the entire stump acts as an anti-kickback mechanism.
- This offers the sawyer additional protection in some situations such as uphill falling, steep slopes, or when falling around other stands of trees.
- The Humboldt can be advantageous on steep slopes if the downhill side is too high to safely reach with a traditional undercut.

Humboldt Undercut

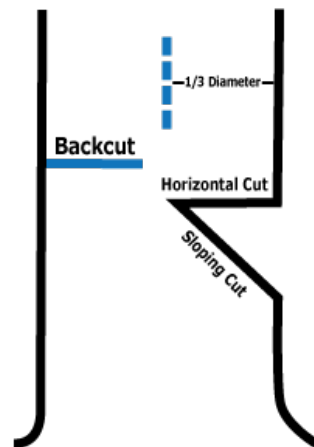

Horizontal Cut

Similar to the traditional undercut but needs to be high enough to have bar clearance for the sloping cut.

- One-quarter to one-third of the trunk diameter cut in width, with gunning sites aimed at target upon completion.

Sloping Cut

The sloping cut is 45 degrees below the horizontal cut.

- The corners must meet together, clean up any mismatched cuts to avoid a dutchman.
- A common incorrect cut is when a notch of less than 45 degrees will apply additional force on hinge wood fibers and could result in a loss of control after the undercut closes.

Figure: Undercut less than 45 degrees.

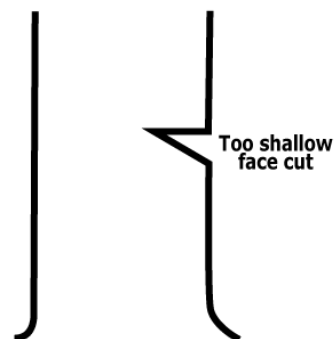

Backcut

The backcut is similar to the face in that it disconnects almost all of the tree from the stump leaving a hinge that helps to control the tree's fall.

- A rule of thumb for backcut height should be no less than one inch above the horizontal cut.

Open-Undercut

The open-faced undercut is 90 degrees which allows the tree to fall to a near horizontal position without the hinge breaking allowing for a greater level of control.

- The rest of the dimensions are similar to traditional and Humboldt undercuts and the hinge operates on the same principles.

Top Sloping Cut

Begin the cut at a 70-degree angle stopping at about one-quarter to one-third of the tree's diameter and with the gunning sights aligned with the target.

Figure: Bottom Sloping Cut

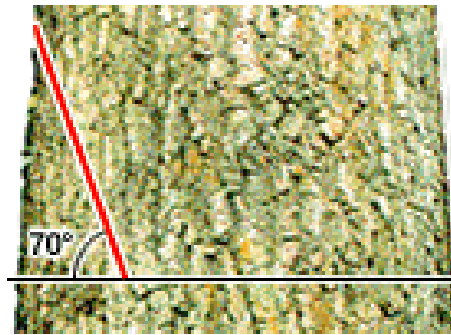

The second cut is from below at a 20-degree upward angle.

- This allows the operator to look through the top cut and see when the bar of the saw on the second cut meets the sloping cut.
- Ideally, you have created a 90-degree cut.

Figure: 90-degree sloping cut

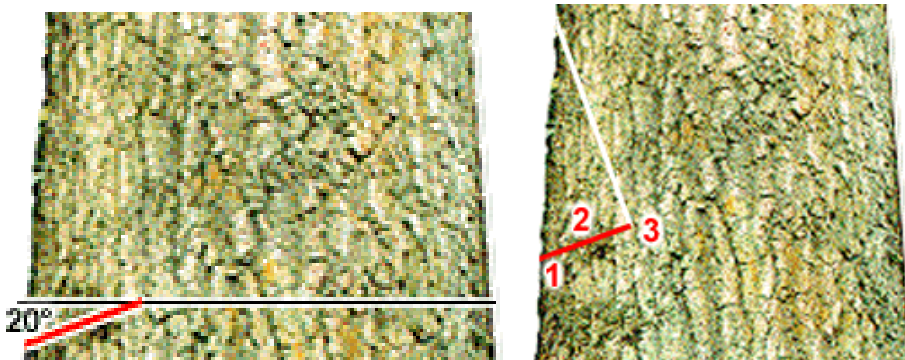

Incorrect Cuts

- Undercut less than 90 degrees which diminishes the advantages of the cut.

Figure: Undercuts less than 90 degrees will increase the forces on tree which may cause barber chair.



- Dutchman

Figure: The top and bottom cuts do not meet, resulting in a Dutchman.



Backcut

Start one to two inches above the corners of the undercut which provides stump shot for the falling tree to push against in the event of hinge failure.



- However, stump shot that is too high results in a poor hinge, reducing the effectiveness of the undercut.

Felling Away from the Natural Lean

Typically, trees can be felled up to 45 degree off their natural lean by properly adjusting the cutting plan and wedging plan.

- The direction of the undercut may vary depending on the amount of lean.
- A wedging plan may be necessary depending on the amount of lean involved.

Wedging

Wedges are used to fill the newly created kerf in case the lean was misjudged, the wind causes the tree to set back, or the sawyer intends to fall the tree in a direction that differs from the tree's natural lean.

- It is recommended to use at least one wedge in every tree to prevent the tree from sitting back.
- The size of the wedge should be appropriate to the tree diameter and depth of the backcut.
- Keep wedges and an ax or pounder accessible while making the backcut.
- Place wedges in the kerf as soon as the chain and bar will permit.
- Initially wedges do not need to be driven in too hard.
 - As the backcut progresses, monitor for gaps between the kerf and the wedges and continue to tap as needed. Wedges can also be used as a visual indicator of kerf movement.

Figure: Wedges need to be parallel to the direction of the intended target.

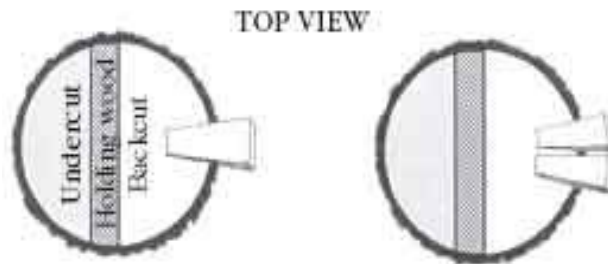

For trees that have a moderate amount of side lean, two wedges may be inserted on the side of the backcut that has been cut first.

- It is essential to tighten the wedges often, especially on trees that are attempting to sit back.
- Have wedges and pounder easily accessible to minimize sawyer exposure.

Be sure to look up after each strike on the wedge to assess for limbs or debris which may come loose.

Small Tree Wedging

Small trees can limit the use of even small wedges. A quarter-cut technique can be employed where half of the backcut is made at a time which allows wedges to be placed without interfering with the guide bar.

- After the undercut, cut half of the backcut using the guide bar's tip from the trees offside.
- Watch out for kickback and be careful not to cut the hinge wood.
- Finish the backcut from the good side leaving the appropriate amount of hinge wood.

- After removing the saw, place a small wedge in the kerf an inch or more from the remaining wood to be cut.
- Remember to keep the wedge tight but do not drive the wedge too hard. Finish the backcut using the tip of the guide bar, being prepared for kickback from the wedge.

Sit Back

A sit back is a tree that settles back opposite the intended direction of a fall during the backcut.

- A wedge in every tree is insurance against sit back.
- Sit back on a small tree may be pushed by hand to remove the saw and insert a wedge.
- Sit back on a larger tree is more hazardous and may require a second undercut in the opposite direction or consider other options to cutting.



After felling trees, flush cut the stumps as close to the ground without hitting the dirt with your chain. Low cut stumps are not as noticeable and present fewer hazards to others.

Felling Observers and Spotters

The use of personnel other than swampers in felling operations vary between agencies.

- Many accidents and fatalities have involved extra personnel in the work area.

However, some organizations are comfortable with sawyer-swampers working as teams for additional situational awareness which can also limit the time the sawyer is working at the stump.

Kerf and Slash Cuts

When felling trees smaller than five inches in diameter, an undercut may not be needed.

- Kerf Cut – A single horizontal cut one-third the diameter of the tree may be used in place of an undercut followed by a backcut. The proportions of the kerf cut, hinge wood, and backcut remain the same as a traditional undercut.
- Slash Cut – A slash cut is a single cut with approximately 30 degrees of slope. The dimensions are about the same as a traditional backcut with the remaining wood functioning as hinge wood. There is no undercut or kerf cut used. Slash cuts can also be cut completely through the tree, allowing it to fall towards the low side of the cut.

Chapter 9 – Advanced Felling

Advanced felling requires the mastery and practice of basic techniques by experienced sawyers applied to more complex and diverse situations.

All sawyers will determine whether a tree needs to be felled or if there are other options such as moving the fireline, equipment use, or creating no-work zones.

Standards

- Sawyers will recognize situations that increase complexity and require an advanced felling skill set.
- Sawyers understand regional variances will affect the size up and complexity in every cutting operation.
- Sawyers will have adequate equipment for the felling operation including the following: chainsaw powerhead in good working condition, proper bar length, correctly sharpened chain, sufficient fuel, and oil supply, felling axe or wedge-driving tool, and appropriate wedge size, type, and quantity.
- Sawyers will evaluate the cutting plan to ensure the knowledge, skills, and qualification levels are appropriate for implementation.
- Sawyers will utilize accepted cutting techniques to meet the cutting plan.
- Sawyers recognize complexity changes during felling operations, constant awareness, and reevaluation of escape path(s) and safety area(s) must occur.

Narrative

The above standards are supported throughout the following six topics.

Large Diameter Tree Felling

Standards

- Sawyers understand the importance of lining up cuts when operating on larger diameter trees.

Narrative

When felling large diameter trees, when the saw bar is not long enough to make an undercut from one side, it will require operating from each side of a tree.

The specific mechanics of double cuts are not any different than traditional undercuts, but they do present additional challenges.

- Matching cuts from side-to-side.
- Making a clean undercut without a dutchman or severing the hinge wood.
- Setting a uniform amount of hinge wood.
- Making cuts with straight and uniform planes. Larger cuts often drift due to the sawyer adversely applying pressure through the saw or improperly filed chain cutters.
- Correct dimensions with boles that are not evenly round.

- Leaving a “post” in the backcut, a column of hinge wood preventing the tree from falling.

Figure: When developing your cutting plan minimize the amount of walking from side-to-side to reduce exposure and finish the backcut from the best side of the tree.



Double Cut Process (Same for All Types of Undercuts)

- 1) Trim Bark – Remove thick bark greater than four inches which will allow the sawyer an accurate view when matching the horizontal and sloping cuts. Removing bark around the backcut will provide an opportunity to visually inspect the wood, allow wedges to be driven further into the kerf, and to provide a solid wedging platform. This also makes observing kerf movement easier as the tree begins to fall.
- 2) Mark Corners – Marking the corners of the undercut will help match the horizontal and sloping cuts and prevent dutchmans.
 - a) One method is to have your swamper hold one end of a piece of p-cord between the intended target of the lay and the first corner, approximately one-third of the tree diameter and the height of the intended horizontal cut.
 - b) While still holding the opposite end of the cord in place, mark the opposite side of the tree at the same height.
 - c) With practice this method will ensure the undercut is accurately square to the lay and minimize misaligned cuts.
- 3) Mark Backcut – A small horizontal cut at the desired height of the backcut will help visualize the proper bar height before committing to the backcut.
- 4) First Side Undercut – From the marked corner start the horizontal and sloping cuts from one side. Be sure to use the gunning sights and stop at the set corner mark.



- a) Optional step – Before continuing to the offside undercut it may be helpful to remove a section of the undercut which will allow visual reference while finishing the offside cuts. While facing the undercut bore-in to remove most of the section that has been cut so far. Be sure to leave at least four inches of kerf to use as a guide for the offside cuts.



- b) Knock out the undercut with a sharp blow from the flat side of a felling axe or pounder to the center of the undercut. Larger undercuts may require several bore cuts and a wedge in the kerf to split and break loose.



- 5) Offside Undercut – Reinsert the bar into the existing kerf and continue the cut until the mark for the offside corner is reached. Repeat the process with the second cut to where both cuts meet. Check your gunning site and that the undercuts match and correct any mismatched cuts.



- 6) Backcut – Ensure fuel level is full, place wedges, and falling tool in an easily accessible location.
a) Double check that the work area is clear and give warning shouts with the saw shut off.

The most common error when starting the backcut is poor alignment and drifting cuts resulting from inadvertently torquing on the saw which changes the angle of the cut.

Common Backcut Patterns

1. Backcut on Offset Side

- To line up the backcut, stand next to the tree facing the target at 90 degrees. Hold the saw level at the desired stump shot height, set the dogs approximately three to five inches behind the desired hinge and begin cutting. Stop cutting once the hinge wood is set.

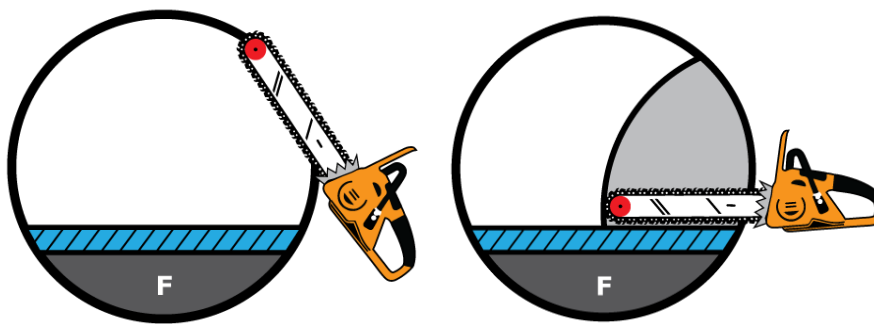

- Reset the dogs five to six inches towards the back of the tree and cut to the hinge wood. Be careful to not cut any hinge wood. Insert a wedge once there is room.

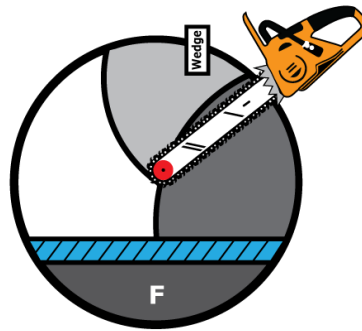

- When there is clearance to complete the cut from the good side, Flip the saw, and continue cutting. Set another wedge when possible.

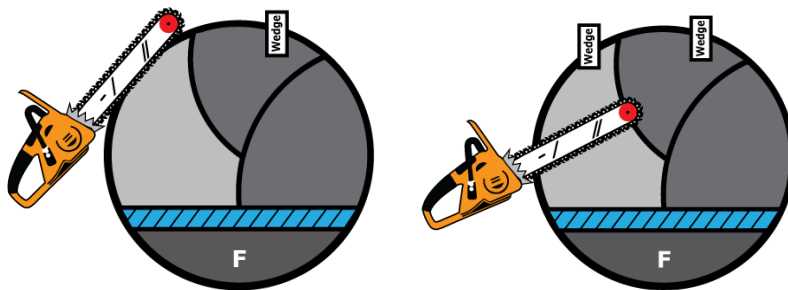

- Continue to cut until the desired hinge wood is set. Be watching the kerf for tree movement.

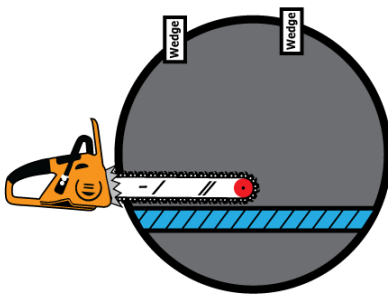

2. Cutting Offside Hinge Wood with Tip

- With the chain stopped, set the tip at the hinge wood width on the offside.
- Begin cutting with the saw perpendicular to the undercut.
- Cut back until the dogs are set and continue the cut pivoting on the dogs. Set a wedge when possible.
- Continue cutting and resetting the dogs around the tree and finishing on the good side.

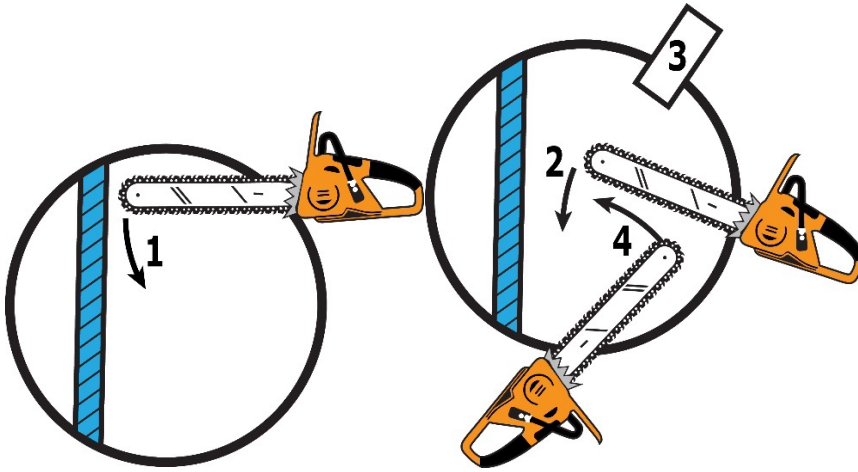

3. Dogging to the Offside

This method provides a uniform shelf around the backcut perimeter which then can be used to complete the cut.

- Set the dogs at the hinge wood of the good side and begin cutting just to the width of the bar.
- Reposition the saw towards the end of that cut, set the dogs, and cut again to the width of the bar.
- Continue this pattern to where the bar can cut to the hinge wood on the offside.
- Pivot the cut from the dogs and continue cutting. Be careful not to cut the hinge wood. Continue cutting the interior wood and repositioning back wood until you have reached the hinge wood on the good side. Place wedges as appropriate.

4. Boring Heartwood

Boring heartwood may minimize the amount of pounding and wedging needed to fell a tree against its lean. It is considered an intermediate to advanced technique which requires strong boring skills and an understanding of its advantages and disadvantages before considering it.

- Do not attempt this cut with a tree with compromised hinge wood.

Advantages

- On green trees it can also be a benefit where the fibers are so strong and flexible.
- May reduce exposure wedging and pounding on dead and fire-weakened trees where wood fibers are so brittle and there are many weak branches and often dead or weak tops.
- It can initiate falling in the intended direction faster because there are less fibers to break thus reducing the risk of getting hung up on adjacent limbs.

Disadvantages

- May compromise directional falling if integrity of hinge wood is compromised by rot or fire damage. A good size up includes inspection of hinge wood after the undercut, before preceding to a bore cut.
- Should not be used to fell more than 15 degrees off lean for dead trees. Green trees with flexible wood fiber may be felled further off lean.

Method

- Using the horizontal cut of the undercut as a guide, bore into the center of the tree and remove interior wood that are out of reach from the sides. Be careful to minimize cutting hinge wood and to keep equal amounts of hinge wood on each side. This option increases exposure to the target area and is not advised with compromised hinge wood.
 - Another option is to bore-in from the back side of the tree. This option increases exposure to barber chair, so it is not advised for trees with heavy lean.
- Bore the saw into the offside and cut to the hinge wood.
- Cut back towards the rear of the tree repositioning as you work towards the good side.
- Continue to the good side and complete the cut until the hinge wood is reached.

Figure: a) How to Fell a Tree. b) Boring heartwood from the undercut. Boring heartwood from behind the tree.

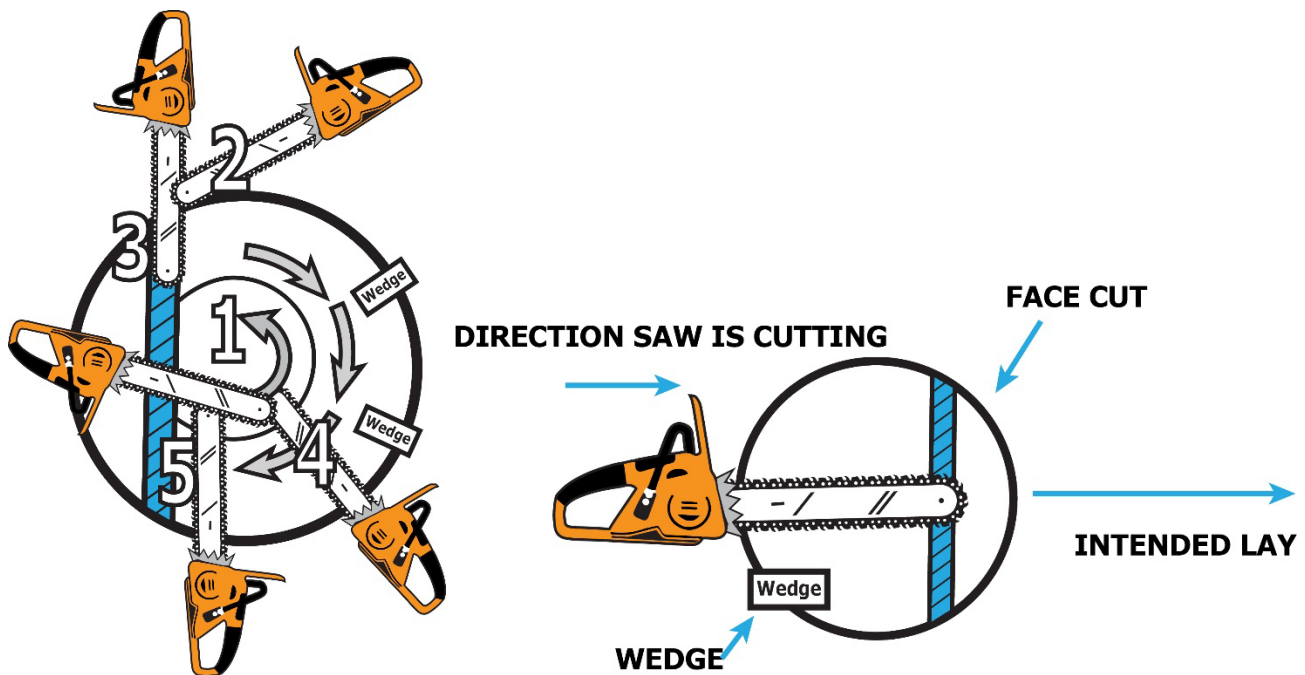

Large Tree Wedging

Placing a wedge in every tree will provide insurance in the event of wind or misjudged lean. Set wedges as soon as there is adequate clearance room in the backcut to prevent the saw from striking the wedge and preventing the tree from sitting back. Periodically drive wedges in as the cut progresses.

- Wedges aligned towards the target will offer maximum lift.
- Use multiple wedges placed side-by-side to distribute the weight across a greater area.
- Work the wedges together by striking one wedge at a time, slowly working the wedge combination into the kerf at the same rate to achieve maximum lift.
- Stacking wedges will increase the amount of lift. Rifled wedges can be used, or smooth wedges should be crossed a roughly 90-degrees to one another placing dirt or woodchips between the wedges will help to prevent them from popping out at high velocity.

- Too large of a hinge or stump shot will contribute to unnecessary wedging and exposure, utilize 10-percent tree diameter at breast height (DBH) as a guide to determining maximum hinge thickness and alter to suit conditions.

Leaner Trees

Standard

- Sawyers must identify tree lean in feet/inches to verify the lean is within acceptable limits and that the wedging operation will be successful for the tree to be felled.

Narrative

Cutting Method for Back Lean

The quarter-cut technique can be used on green trees with good hinge wood fiber.

- Cut 1 – Undercut towards target.
- Cut 2 – From the offside, cut one-half of the backcut. Drive wedge as soon as possible.
- Cut 3 – From the good side, finish backcut driving another wedge as allowed.

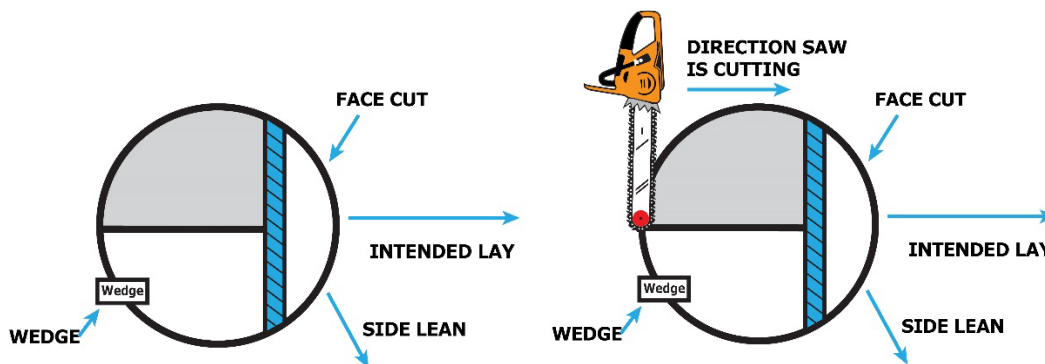

Cutting Method for Heavy Head Lean

Trees with a heavy head lean are susceptible to barber chair due to the high amount of tension the wood fibers running along the bole on the opposite side the lean.

- Mitigate the chance of barber chair by performing a boring backcut which severs internal wood fiber and relieves tension forces. This allows the hinge to be set across the bole of the tree evenly before the tree begins to commit to the lay.
- This technique, when done correctly, will reduce the chance of barber chair and is the safest option when felling a head leaning tree and hardwood species that are prone to barber chair due to natural wood fiber characteristics.
- Do not attempt a bore-in backcut if hinge wood is compromised.

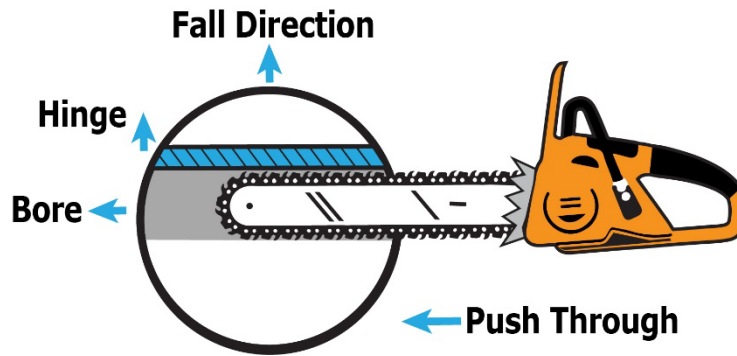

Cut Sequence

- Undercut – This wood is under high compression so be sure to watch the kerf to minimize bar pinch. A one-quarter diameter or smaller undercut is standard and can be varied depending on amount of lean. Removing the undercut using a series of smaller undercuts placed at increasing depth may be required to prevent bar pinch.
- Bore-In Cut – Bore behind the hinge wood at about the middle third of the tree and cut forward towards the undercut stopping when the desired hinge wood thickness is set. Utilize gunning marks aligned with the target to ensure hinge thickness is even across the stump.
- Backcut – Remove the saw and flip the bar over before progressing the cut towards the back of the tree. Stop when there is a strap of unsevered wood approximately 10% of the tree's diameter intact across the stump and remove the saw.
- Finish Cut – The final cut, which can often be made using only the tip of the bar, is made from the back of the tree and cut forward severing the remaining strap of wood. To prevent high release of energy avoid severing all the tension wood, allowing wood fibers to be pulled from the tree and thus slowing the tree's release. This allows the sawyer a greater degree of safety by allowing the sawyer to stand further from the tree during the final stage of the backcut and provides more time to escape. To avoid having the saw pulled up and away when severing the back strap, come in one kerf width or more below the bore-in portion of the backcut.
- When cutting a large tree with a small bar, you can use a double cut technique by boring in from each side, provided the integrity of the wood in the finish cut is sound.

Hang-up Trees

Standard

- Sawyers recognize, anticipate, and predict the potential movement and reaction of hung trees involved when implementing the cutting plan.

Narrative

Many sawyers approach a hung-up tree without a specific plan and cut a vertical slash cut, commonly known as fence posting. The pitfall with this technique is that the tree will drop straight down giving the sawyer little opportunity to get out of the way and the tree will often become more vertical with each section cut.

- The more vertical a hang-up tree becomes the less control a sawyer must influence or control its direction of fall.

The use of undercuts and a hinge help to provide some directional control and may be the safer option when considering removal.

Size Up

A full and complete tree size up is essential to all saw operations and is increasingly critical to life and safety when choosing to remove a hung-up tree. A size up is best completed by the sawyer and swamper together to minimize overseeing any hazards and to develop the safest plan possible. Forces within the hang-up and supporting trees need to be evaluated for compression, tension, and side bind. This will provide clues to how the tree will respond to cutting. Remember, the safest plan may be to simply avoid the hung-up tree and not attempt to remove it.

Essential Factors When Considering Removal of Hang-up Trees

- Is the top of the hang-up tree visible or obscured?
- Determine whether the tree is hung solidly. Always treat hung-up trees as if they can come down at any moment and never stand under the lean. Are the limbs, bole, or both causing the hang-up?
- If a tree is solidly hung up and the limbs intact it may not need to come down.
- Is the tree still attached to the stump? The tree should be first cut free from the stump when safely possible.
- The closer a hung-up tree is to vertical will often increase the complexity of the saw operation because control can be easily lost, making the tree more likely to fall back towards a sawyer's escape path. A tree can always react unpredictably when released.
- What is the condition and strength of the hung-up tree and supporting tree: alive, dead, fire-weakened, or decayed?
- A rotting or burning base needs to be evaluated for integrity so it does not fail during the cutting process.
- Other hazards in the area (rolling hazards, adjacent trees, fire-weakened tops, widow makers, etc.) need to be part of the risk analysis and size up.

Often complexity and risk increase while cutting hang ups, but the sawyer does not pause to reevaluate the increased risk. After each cut, reevaluate the situation.

Develop a Cutting Plan

- A hung-up tree is most often a sign of high complexity cutting operation, and the complexity can either increase or decrease with each action taken. Identify which circumstances are the most likely to reduce complexity and the associated risk when selecting which mitigations to implement.
- Determine where the butt of the tree needs go to meet your objective. Planned cuts should reduce the angle of the hang-up.
- Consider options that may allow the tree to become more hung up and eliminate the need for removal.
- Create contingency plans for unforeseen circumstances.
 - How will we get someone out of here if they get hurt?
 - Top of leaner breaks and falls back towards the sawyer (changing escape plan).

- Hung tree strikes other trees or limbs and falls back towards the sawyer (hazard assessment of surrounding area).
- Hung tree strikes trees which causes a chain reaction of multiple trees falling (maintain work area control utilizing two times the tree height).

Techniques

A. Scissor Cut

Utilizing an open-face undercut to separate tree from stump.

To reduce exposure to the sawyer, consider two opposing undercuts to sever the tree from the stump.

- Cut an open-face undercut in the intended direction you would like the bole of the tree to move. Undercuts should be as wide as possible to allow for more movement before the undercut closes and the hinge breaks.
- A second undercut placed above the first and 180 degrees in the opposite direction. The greater the distance between the two undercuts, the farther the bole will be able to move once released.
- Place a backcut in the top and bottom undercuts, keep an eye out for kerf movement and stop progressing the cut just as the kerfs begin to open.
- The tree is now ready to be either tapped with a wedge in the lower cut, tapped with a tool, or pulled with a rope from a safer distance. Choose the method that allows the greatest margin of safety for the sawyer to stand back from the tree as it breaks free.

Figure: The lower undercut is on the underside of the log and the upper undercut is opposite.

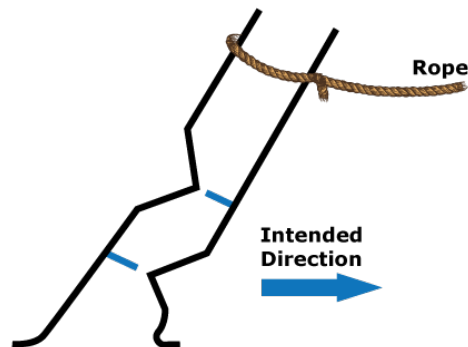

B. Bypass Cut or Fenceposts

Kerf cuts that cause the tree to drop straight down. Fence posting quickly drops the leaner straight down leaving little time for escape. This may lead to a situation where the hung-up tree is nearly vertical and could fall in almost 360degree in an unpredictable direction.

Make the first cut perpendicular with the ground, cutting down from the top or the stem, finish cutting the off side of the bole first while leaving the remaining fiber intact.

- Stand back and continue cutting using the tip of your bar until kerf movement is observed. This will help determine what type of bind is present, depending on whether the kerf is opening or closing, and what the next steps are to proceed.
- Make the second cut offset approximately one-half inch or a saw kerf-wide towards the bottom of the stem.

- Continue monitoring the kerf and cutting until just before the cuts bypass. Step back and reassess your escape route and reposition yourself so that the cut can be completed at arm's length utilizing only the tip of the bar. Complete the cut by cutting until the two kerf cuts bypass or meet and the tree should shear off and drop straight down to the ground.
- This cut when performed correctly can be a safe option to remove a hung-up tree and will result in fewer cuts, less time, and subsequent exposure.

Figure: Fence Posting

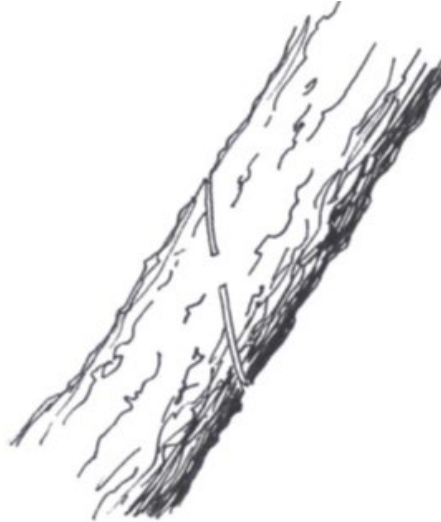

C. Directionally Falling a Leaner

This may be a safer alternative depending on conditions, although both cuts can be performed in a way that allows the sawyer to step back, the addition of a rope will provide an increased safety margin as the sawyer can stand further away when the tree falls.

- Can be attempted if a tree has been severed from the stump.
- Cut an open-faced undercut 180 degrees away from the intended direction to move the butt of the tree.
- Cut the backcut from the opposite side of the undercut. Stop just when the kerf begins to open. Knock the tree loose with a tool or felling axe after safely stepping back.

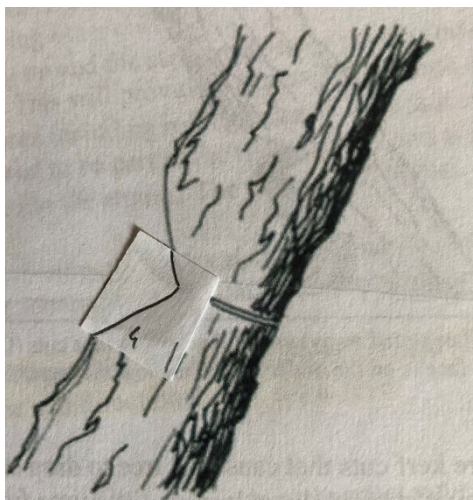

Use of a Rope for Increased Safety Margin

- After the undercut is in, tie a rope, or p-cord, above the cut.
- Make your backcut. Begin with the offside and finish with the bar tip while stepping back. Be ready to use your escape path. Stop when the kerf slightly opens.
- From a safe distance pull the rope to release the tree.

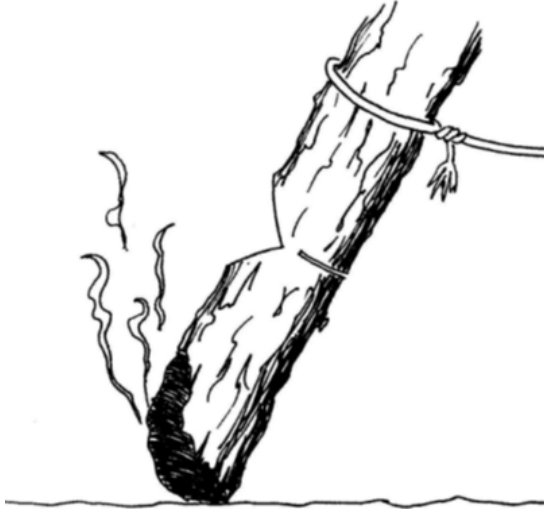

D. Lever Technique

Twisting a hang-up tree is also an option in certain situations, a hang-up tree with sound limbs may be turned or twisted to release it. Be careful that all limbs have been removed that have a chance of catching or hitting the sawyer once the tree starts to spin.

A long lever can provide a mechanical advantage and allow a sawyer to stand a further distance from the tree for increased safety margins. This is an advanced technique that requires vertical and horizontal boring operations. The hung-up tree fibers connecting the bole to the stump will need to be mostly severed from the stump or cut up to a point that will allow for torsional movement of the tree bole.

- A felling lever, peavy, or cant hook are the best options to use as a lever when attempting to twist a hung-up tree free from another and causing it to roll to the ground.
- When considering utilizing improvised lever that requires a square hole be bored in the hung-up tree, ensure the tree diameter is large enough to accept the width of the bar when boring and that enough solid wood will remain on either side of the bore hole so it will not break or shear when force is applied as the lever is twisted. Bore a square hole that is parallel with the ground and at a comfortably and safe height.
- Select a branch or log of the correct size and length that will fit the bore hole and that will withstand the forces exerted when twisting the hung-up tree. While green trees or limbs may flex too much, especially when too small a diameter is selected as a lever. Dead material can work well so long as it is sound enough to not break under pressure. A lever needs to be long enough to provide leverage and distance from the hung-up tree, but short enough to clear the ground and surrounding obstacles.
- Slowly begin twisting the lever in the desired direction. Utilize your escape path and be well away as the tree begins to fall to the ground in some situation a rope could be added to pull the lever from a safe area further away.

E. Other Options

- Fall the hung-up tree and supporting tree as a group—falling both may be a safer alternative by shifting exposure away from the leaner to the support tree. Be aware of the reaction of both trees and the possibility of being underneath the leaner as it releases.
- Driver tree – consider falling another tree into a hang-up after carefully evaluating the additional complexity. It is not a prohibited action by OSHA to remove a danger tree by felling another one into it. Be aware of the likelihood of increasing the overall complexity of the situation.

Limb-Tied Trees

Standard

- When situations dictate that two or more limb-tied trees be felled together as a single unit, sawyers will construct an undercut and place wedges in each backcut before moving to the next tree in a sequence. Begin by setting up the smaller diameter trees first so that the last and largest tree in the group can be used to commit all limb-tied trees towards the lay in a single group once the final backcut is made.

Narrative

- Begin with the smallest diameter tree first. Complete the undercut and the backcut to the desired depth and place a wedge snugly in the kerf.
- Continue the sequence until all trees in the group are cut up and ready to be felled.
- The final cuts are made to the largest tree in the group (driver tree) and performed in the same manner as those trees preceding it. However, be prepared to utilize the escape path as once the backcut is completed and the wedge set, the group will begin to commit towards the lay and fall as a single unit.
 - Felling limb-tied trees as a group is considered a complex saw operation and should only be attempted by an experienced sawyer.
 - Ensure a well-developed escape plan is in place and utilize another green tree as cover whenever possible.

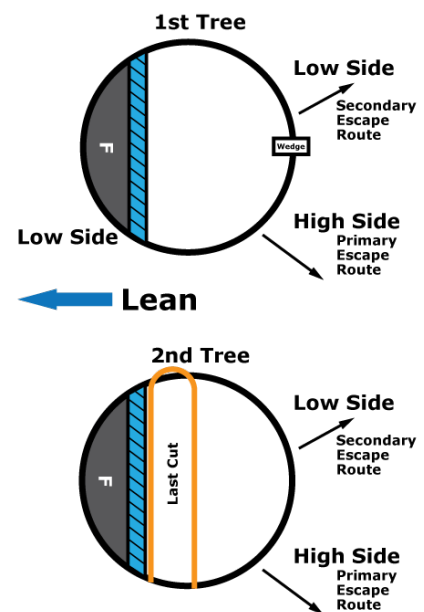

Steep Slopes

Steep slopes present additional hazards for sawyers.

- Misjudging Lean – Slopes can make it difficult to determine tree lean. Always attempt to determine lean from the uphill and directly to the side when attempting to read the lean and use a plumb bob to ensure your accuracy.

- Roll Out – Slopes will influence a tree and can cause it to roll or bounce after falling or when being bucked which may compromise escape paths. Falling a tree directly up hill is often the safest placement for a tree and should be done utilizing a Humboldt or appropriate stump shot to help hold the bole of the tree in place after being cut. Avoid falling trees directly downhill as trees may “torpedo” down slope and compromise the safety of others.
- When multiple trees will be felled or bucked on a slope it can be advantageous to leave a larger stump height to help retain trees and logs in place and prevent them from rolling.
- Cutting Heights – cutting on slopes is often made more difficult due to poor footing and significant height variations between the downhill and uphill side of the tree. Humboldt undercuts are the preferred option on steep slopes and may end up being the only way a sawyer can reach all the cuts needed to safely fell a tree.
- Carve out solid footing areas to work from using hand tools in dirt or consider cutting notches in the roots for better footing.
- Bucking – Avoid equal length and width cut sections when bucking as these dimensions tend to quickly gain momentum when rolling downhill.
 - The best practice is to develop a plan for how the severed section of log will be retained in place after the cut is made. You never want to lose control of logs that will threaten the safety of others below the bucking operation.

Never fall or buck directly above or below others working on a slope. Coordinate with all resources above and below to stagger work teams and minimize the potential of becoming a target.

Fire-Damaged Trees

Felling fire-damaged trees adds additional complexity to felling operations. Fires often hide visible external defects and create new defects by consuming portions of the tree, typically where decay was present. Fire-weakened trees often fall without notice and are responsible for numerous firefighter fatalities and serious injuries.

- The scope and scale of Hazard Tree felling post fire also increases operational complexity due to the large number of trees that will likely need to be felled before an area can safely be accessed.
- Even a tree that survived a fire and appears healthy can have root system damage and fall unexpectedly.
- When large catfaces, burn scars, or only portions of the tree bole remain, cutting techniques and procedures will likely need to be altered and require advanced level knowledge and experience.
- Trees with broken out tops or decay columns in the heart wood can catch fire embers in tree cavities that can easily ignite. These snags or “stove pipes” are extremely hazardous because remaining rind thickness left inside the tree cannot be determined. And the cylindrical shape of the bole allowing airflow often intensifies fire activity and subsequent combustion of remaining wood fibers inside the tree, thus further weakening the tree. The loss of tree canopy and internal tree weight, along with high heat from active fire, can make falling these snags extremely difficult.
 - In all these situations, it is important to continually size up the tree as conditions change and consider alternate options to hand felling. This is considered a highly complex operation.

Fire-Damaged Tree Size-Up Considerations

- Determine if a tree has a target. If workers do not need to be in the area leaving the tree may be the safest option and that tree could be available for wildlife.
- Evaluate the amount of rind from the area with the least amount of remaining wood. A good rule of thumb is that the rind should be at least 1/3 of the stem radius.

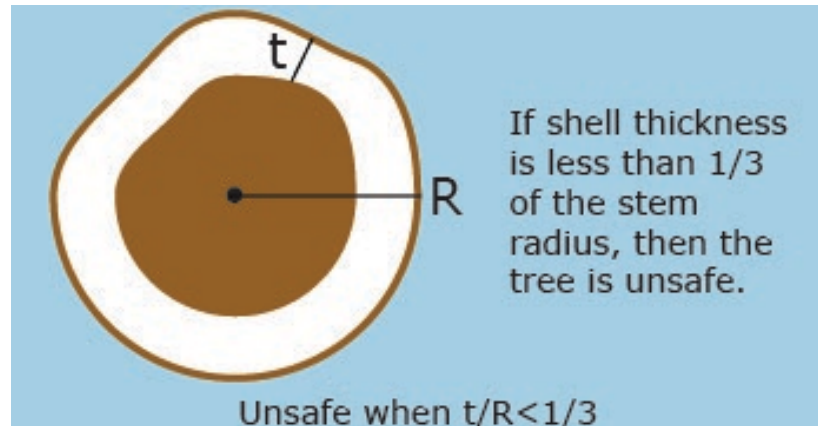

- Evaluate the tree for hinge wood throughout the operation. Ideally, create a hinge across the bole taking into consideration burned, hollow, or missing wood sections and treating them as if the whole tree is still intact.
 - Fall with the primary lean whenever possible to avoid pounding wedges as tops, branches, and the bole are weakened and prone to failure.
- Evaluate root system for fire damage. Be extremely cautious of damaged root systems especially those that have less than 50% of the roots system intact.
- Consider the pre-fire condition of the tree. Decayed wood may have been consumed by fire increasing a tree's instability.
- Existing dead and fire-weakened trees will likely have brittle wood fibers and increase the likelihood of hinge failure during falling options.
- Try and eliminate the need to wedge over a fire-weakened tree and use extreme caution when it becomes necessary as overhead hazards are present and often numerous.

Many serious injuries and fatalities have occurred when sawyers failed to complete a thorough tree size up before beginning saw operations. Critical steps have also been overlooked when conditions change, and the original objective has not been reassessed before continuing the operation. A size up must be an ongoing and continual process, especially when felling fire-weakened trees. Do not hesitate to walk away from a situation when a tree has been found to be too hazardous to cut. Flag off the area and consider other options.

- Consider the compounding effects of fire on dead, decayed, or previously damaged trees.

Figure: Fire-damaged trees have failure potentials.

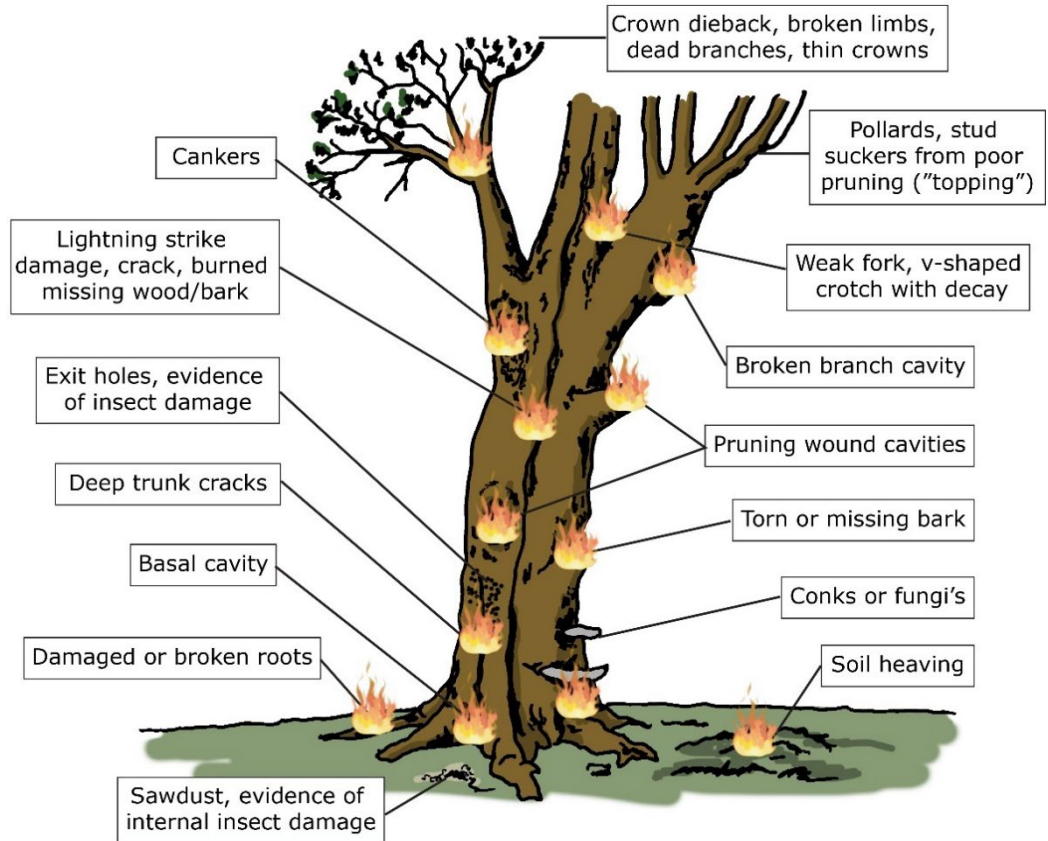

Figure: a) Fire-damaged trees. b) Some trees are best left alone.



Candlesticks

- Candlesticks or stovepipes are trees with broken off tops and hollow cores that have been fire-damaged or are currently burning.
- With no canopy, a hollow core, and/or little lean can make these trees difficult to fell utilizing a traditionally sized one-third diameter undercut.

- An oversized undercut of approximately one-half the tree diameter will help shift the tree's natural balance forward into the undercut allowing the tree to commit more easily towards the intended lay.
- The hinge wood available may be limited to a few inches of rind on either side or could be significantly compromised in the center of the tree. Take the time needed to perform a thorough assessment of the wood fiber available at the hinge during the size-up process.

Figure: Candlestick with $\frac{1}{2}$ diameter undercut.

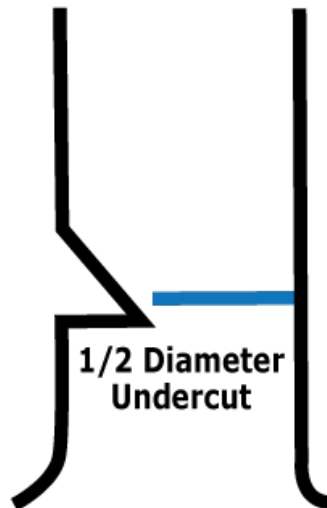

Appendix A: Common Sawyer Specific Duties

Prepare

- 1. Remain mentally and physically fit and able to determine when conditions have changed, affecting your fitness for duty status.**

When to start task: Mental and physical fitness is a constant state.

Specific resources to complete task:

- *NWCG Standards for Wildland Fire Position Qualifications*, PMS 310-1
- *Fitness and Work Capacity*, PMS 304-2

How to accomplish task:

- Mental Well-Being Standards
 - Sawyers recognize the impacts of mental health on job performance and safety.
 - Sawyers must understand how mental well-being impacts their safety and performance on the fireline.
 - Before you pick up your saw, consider your current state of mind. Even when intentions are to focus on a work assignment, mental factors can intervene.
 - It just takes one moment of distraction for a negative outcome to occur. If a sawyer is feeling distracted, use the opportunity to pass off the chainsaw.
- Physical Well-Being Standards
 - Sawyers must be physically fit and successfully pass the wildland fire work capacity test as defined in the *NWCG Standards for Wildland Fire Position Qualifications*, PMS 310- 1.
 - Sawyers must understand how physical well-being impacts their safety and performance on the fireline.
 - When operating a chainsaw, it is crucial to note that this task is a balance of using technique and muscular fitness to accomplish cutting objectives.
 - Proper posture and muscular strength of the lower body, torso, and shoulders provide a stable foundation from where the chainsaw can be manipulated.
 - The necessary muscular endurance and proper chainsaw handling should be emphasized to prevent a lapse in control of the chainsaw.

- 2. Ensure individual and equipment readiness.**

When to start task: Any time you are ordered to a new assignment or reassigned to a different task, not only is it important to be mentally and physically ready for the assignment, but to also ensure your equipment is ready and appropriate for the assignment.

Specific resources to complete task: PMS 212, Chapter 5 – Chainsaw Components, Maintenance guides, repair parts, and equipment specific owner’s manual.

How to accomplish task:

- When experiencing mental or physical fatigue and stress, be sure to communicate this with your fireline supervisor to allow for recovery or down time.

- Emulate best practices regarding condition of equipment, tools, and supplies, see reference below:
 - *NWCG Standards for Wildland Fire Chainsaw Operations*, PMS 212, Chapter 5 Additional Equipment.
 - List of commonly needed replacement parts with item numbers specific to the make and model of equipment being used.
 - Commercially manufactured axe or wedge-driving tool of sufficient size and weight that meets OSHA standards.

3. Continually strive to improve, learn from others, and develop safe practices that reinforce good habits and decision making.

When to start task: From the time of hire and throughout a career, the learning process is an important factor in honing and improving skills.

Specific resources to complete task: None

How to accomplish task:

- Seek performance feedback from trainers and more experienced sawyers.
- Learn from mistakes by talking about them and seeking to improve.
- Foster a learning culture, where accidents are reported and analyzed, to benefit others' learning.
- Study learning products (Facilitated Learning Analyses [FLAs], RLSs, etc.) and utilize near misses to increase awareness of contributing conditions of accident precursors.
- Make predictions about the effects of each cut and regularly compare outcomes with predictions to improve prediction certainty.
- Under the immediate direction of a more experienced and qualified sawyer, size up and engage in cutting operations which foster growth and development.

Mobilize

1. Gather critical information pertinent to the assignment.

When to start task: When ordered as a single resource.

Specific resources to complete task:

- Home unit.
- Dispatch centers.
- Assignment point of contact (POC).

How to accomplish task: Work with home unit, dispatch centers, and assignment POC to ensure all critical information related to the assignment is obtained.

2. Travel to and check in at the assignment. Notify incident supervisor and/or dispatch when arriving at the incident.

When to start task: When ordered as a single resource.

Specific resources to complete task:

- Home unit.

- Dispatch centers.
- Assignment POC.

How to accomplish task:

- Work with home unit, dispatch centers, and assignment POC for travel and check-in information.
- Notify the incident supervisor and/or dispatch of expected arrival time at the incident.

3. Obtain initial briefing from supervisor.

When to start task: When ordered as a single resource or as part of a crew/module.

Resources to complete task:

- Incident supervisor.
- Incident information portals such as Inciweb.

How to accomplish task: Obtain an initial briefing from the incident supervisor and be sure to clarify any questions prior to beginning the assignment.

Build the Team

1. Model leadership values and principles

When to start task: Developing leadership values and principles is a continual process and skillset that is honed over time. Opportunities to influence and mentor others should be sought out and prioritized as operational tempo allows.

Specific resources to compete task: *IRPG* – Operational Leadership, Communication responsibilities, Leaders Intent, Human Factors, After Action Review (AAR).

How to complete task:

- Provide opportunities for mentorship.
- When mentoring, ensure that any Advanced, Intermediate, or Basic Faller is modeling behaviors that adhere to policy procedures and the standards of this document.
- Verify that concepts and techniques are understood, and the context of their usage is valid.
- Take every opportunity to perform your duties professionally and with a high standard of quality.

Communicate and Coordinate.

1. Establish and maintain positive communication and coordination with saw teams, your crew, adjoining resources, and supervisors in the work area.

When to start task: Prior to engaging in saw operations and continuously throughout.

Specific resources to complete task:

- Radio
- Verbal and nonverbal communication
- Incident Action Plan (IAP)

How to accomplish task:

- Establish contact with anyone who could be involved in or impacted by saw operations.

- Maintain appropriate communication throughout the saw operations by:
 - Designating a POC to establish and maintain communications.
 - Check in when conditions or operations change or to report progress.

2. Before engaging, receive a thorough briefing from the appropriate supervisor addressing all saw operation specifications and associated expectations.

When to start task: Prior to beginning work assignments report to immediate supervisor to obtain saw operation briefings.

Specific resources to complete task:

- Immediate fireline supervisor.
- Knowledge of the work area.
- IAP.
- *IRPG* Briefing Checklist.

How to accomplish task:

- Receive a thorough briefing and associated expectations.
- Briefings should establish cutting objectives and priorities for the assignment and fireline specifications based on fuels, weather, topography, and expected fire behavior.
- Review and be familiar with the Medical Plan and medical resources close to the work area.

3. Participate in AARs and information sharing.

When to start task: Upon completion of saw operations or when relevant information sharing is needed.

Specific resources to complete task: All personnel involved in saw operations.

How to accomplish task: Use AAR format appropriate for individual situation or group. Relevant information sharing consists of any new information learned after initial briefing which could affect saw operations. Roll up key points to supervisor to share learning.

Manage Risk

1. Apply the Risk Management Process as stated in the *NWCG Incident Response Pocket Guide (IRPG)*, PMS 461.

When to start task: Risk management is an ongoing process.

Specific resources to complete task:

- Refer to the *IRPG* Operational Engagement section for additional information and applicability.
- Job Hazard Analysis or Risk Management Assessments.

How to accomplish task: Review and implement the Risk Management Process as outlined in the *IRPG*.

2. Apply Lookouts, Communications, Escape Routes, and Safety Zones (LCES) to all saw operations.

When to start task: LCES should be established whenever assigned to an ongoing wildland fire incident and reassessed periodically as conditions and work locations change.

Specific resources to complete task:

- Refer to the *IRPG* Operational Engagement section for additional information and applicability.
- IAP for fire behavior, weather, and maps.

How to accomplish task: Review and implement LCES as outlined in the *IRPG*.

3. Plan for and manage medical emergencies.

When to start task: Planning for medical emergencies starts at mobilization and needs to be adjusted as work zones progress along the incident.

Specific resources to complete task:

- Established local procedures.
- IRPG – Emergency Medical Care section.
- IAP.
- Medical Plan (ICS 206WF).
- Radios.
- Medical equipment.

How to accomplish task:

- Identify medical first responders in the work area.
- Identify medical equipment in the work area.
- Review incident medical plans.
- Identify communication procedures for requesting assistance.
- Coordinate with supervisor to establish evacuation scenarios and transportation plans.

4. Report all accidents, injuries, or near misses to supervisor.

When to start task: Reporting of an identified accident, injury, or near miss should occur based on the procedures established by the supervisor and as prescribed by agency policy.

Specific resources to complete task:

- Incident Medical Plan.
- Medical Incident Report.
- Appropriate AAR or Lesson Learned format.
- IAP.
- SAFENET.

How to accomplish task: It is the responsibility of everyone to report all accidents, injuries, or near misses to build a learning culture. Reporting incidents helps to improve sawyer experience and fosters skill development and awareness.

5. Comply with all standards for chainsaw operations as defined in *NWCG Standards for Wildland Fire Chainsaw Operations*, PMS 212, and established agency standards for saw operating procedures.

When to start task: Anytime you are engaged in saw operations, comply with all safety practices and agency established standards for saw operating procedures.

Specific resources to complete task:

- *NWCG Standards for Wildland Fire Chainsaw Operations*, PMS 212.
- Agency specific standards.

How to accomplish task:

- Know and apply the *NWCG Standards for Wildland Fire Chainsaw Operations*, PMS 212 standards and applicable agency specific policies when operating the chainsaw.

6. Establish and maintain work area control

When to start task: When engaged in saw operations.

Specific resources to complete task:

- Radio(s).
- IAP.
- Swampers.
- Additional personnel within the work area (road/trail guards, etc.) to act as lookouts.

How to accomplish task:

- Refer to the *NWCG Standards for Wildland Fire Chainsaw Operations*, PMS 212 – Work Area Control section.
 - The chainsaw operator is ultimately responsible for controlling the work area.
 - No one shall be permitted in the secured work area without the authorization of the sawyer.
 - Supervisors need to support sawyers on work area control measures.
- The saw operator must maintain work area control by ensuring all personnel directly involved in the saw operation who are inside the work area are in a pre-identified safe location and remain there until all saw operations are completed and a verbal confirmation such as "all clear" has been communicated.
 - Work areas shall be identified so that trees cannot fall into an adjacent occupied work area. The distance between adjacent occupied work areas shall be at least two tree lengths of the trees being felled. The distance between adjacent occupied work areas shall reflect the degree of slope, the density of the growth, the height of the trees, the soil structure, and other hazards reasonably anticipated at that work site. A distance of greater than two tree lengths shall be maintained between adjacent occupied work areas on any slope where it is reasonably foreseeable that rolling or sliding of trees or logs would impact the other work area.
 - Avoid working directly below felling or bucking operations.
 - No employee shall approach a faller closer than two tree lengths from trees being felled until the faller has acknowledged that it is safe to do so, unless the faller demonstrates that a team of employees is necessary to manually fell a particular tree.
 - Competent lookouts shall be established and maintained by the faller at all major access points, including roads and trails that provide access to the secured work area.
 - The faller will ensure to identify and make known all hazards that may remain at a hazard tree that could not be mitigated – such as hang ups, unstable logs, or other dangers – before approving access into the work area.

- Faller will designate No-Work Areas where hazards cannot be mitigated and communicate their establishment with supervisors and others who enter the work area.

7. Develop and follow safe cutting area practices when using a swamper during saw operations.

When to start task: Anytime you are engaged in saw operations where it requires the use of a swamper.

Specific resources to complete task:

- *IRPG* – Communication Responsibilities.
- *NWCG Standards for Wildland Fire Chainsaw Operations*, PMS 212 – Sawyer/Swamper Teams.

How to accomplish task:

- Develop and follow safe working distances and communication practices when using a swamper during saw operations.
- Limit personnel in the cutting area to only those necessary to accomplish task.
- Saw team will assess work area and develop tactics appropriate to accomplish objectives.
 - Establish verbal and nonverbal communication procedures to be used during operations.
 - Maintain cutting area control and operational tempo and adjust based on terrain, fuel type, fatigue, fire behavior, and weather (i.e., wind, rain, or snow).

Demobilize

1. Ensure equipment is in good working condition for next assignment and resupply used or damaged equipment as necessary.

When to start task: After each saw operation and when preparing to demobilize.

Specific resources to complete task:

- General Message Form (ICS 213).
- Property Loss or damage Report (OF 289).
- Incident Replacement Requisition (OF 315).
- IAP.
- Incident Supply Unit.
- Finance Section.

How to accomplish task:

- After each saw operation, or daily, refurbish equipment to ensure readiness.
- Work with incident supervisor for approval to replace used or damaged equipment.
- Follow incident resupply protocols. Specific procedures can sometimes be found in IAP.
- FAL3 and FAL2 may be working through their immediate supervisor to accomplish resupply tasks.

2. Return equipment and supplies to appropriate units.

When to start task: When on incident and preparing to demobilize.

Specific resources to complete task:

- Incident Supervisor.
- ICS Unit Leaders where equipment and supplies are obtained.

How to accomplish task: Utilize demobilization checklist and contact the appropriate units to understand the process for returning equipment and supplies.

3. Complete demobilization checkout process before being released from the incident.

When to start task: Prior to demobilizing from incident.

Specific resources to complete task:

- Demobilization Unit Leader.
- IAP.

How to accomplish task: Use local procedures or an incident IAP and contact the demobilization unit to understand the demobilization checkout process before being released from the incident.

4. Upon demobilization, report status to the home unit including reassignment or estimated time of arrival (ETA) to the home unit.

When to start task: When demobilizing from incident.

Specific resources to complete task:

- Home Unit.
- *Interagency Standards for Fire and Fire Aviation Operations* (Red Book).

How to accomplish task:

- Ensuring safety and proper communication, upon demobilization, report status to the home unit including reassignment or ETA to the home unit.
- Follow agency travel guidelines as outlined in the *Interagency Standards for Fire and Fire Aviation Operations* (Red Book).

Common Sawyer Resources:**Personnel:**

- Home Unit Supervisor
- Incident/Fireline Supervisor
- Safety Officers
- Assignment POC
- Sending and Receiving Dispatch Centers
- Supervising Sawyers/More Experienced Sawyers/Mentors

References:

- *NWCG Standards for Wildland Fire Chainsaw Operations*, PMS 212, <https://www.nwcg.gov/publications/212>.
- Equipment owner's manual.
- OSHA CFR 1910.266 Logging Standards, <https://www.osha.gov/laws-regs/regulations/standardnumber/1910/1910TableofContents>.
- S-212, Wildland Fire Chainsaws coursework.
- IAP, incident maps.
- *NWCG Standards for Wildland Fire Position Qualifications*, PMS 310-1, <https://www.nwcg.gov/publications/310-1>.
- *Fitness and Work Capacity*, PMS 304-2, <https://www.nwcg.gov/publications/304-2>.
- *Interagency Standards for Fire and Fire Aviation Operations* (BLM, NPS, FWS, BIA, USFS), <https://www.nifc.gov/standards/guides/red-book>.
- National Fuel Geysers Awareness website, <https://www.nwcg.gov/committees/equipment-technology-committee/national-fuel-geyser-awareness>.
- FSM 2358 USFS National Saw Policy, https://www.fs.usda.gov/sites/default/files/2358-Saw-Policy-TAI-6-11-15_0.pdf.
- NPS National Chainsaw Policy Reference Manual.
- *NWCG Standards for Transporting Fuel*, PMS 442, <https://www.nwcg.gov/publications/442>.

Tools:

- *NWCG Incident Response Pocket Guide (IRPG)*, PMS 461. <https://www.nwcg.gov/publications/461>.
- Note Paper/Writing Utensil
- Radio
- Electronic device (phone/tablet)
- Chainsaw operator PPE
- Chainsaw operator field tool/parts kit
- Chainsaw
- Approved Fuel and Bar Oil Containers
- Wedges appropriate to conditions
- Wedge-driving tool

Appendix B: Advanced, Intermediate, and Basic Faller (FAL1, FAL2, and FAL3) Position Standards

Advanced Faller (FAL1)

The Advanced Faller (FAL1) has multiple years of experience in chainsaw operations and has demonstrated proficiency in performing high complexity saw operations, including tree felling, bucking, brushing, and limbing. The FAL1 may work independently or supervise/direct other Intermediate (FAL2) and Beginner (FAL3) Fallers during fireline saw operations. The FAL1 may serve as a single resource or as a member of a firefighting crew or module. A FAL1 serving as a single resource reports to a Felling Boss (FELB), Strike Team/Task Force Leader (TFLD), or other assigned supervisor. The FAL1 works in the operations functional area.

Build the Team

1. Participates in and/or directs the development and implementation of saw related objectives, priorities, and work assignments for saw team members.

When to start task: Any time you are engaged in saw operations, you may be asked to participate in the development of saw related objectives, priorities, and work assignments for the saw team members. Upon receiving a briefing from fireline supervisor, implement or coordinate assignments as directed.

Specific resources to complete task:

- IAP.
- Maps.
- Additional project related information.
- *IRPG* briefing checklist.

How to accomplish task:

- Attend operational briefing. Additionally, always receive tactical briefing from supervisor. Clarify any directions as needed.
- Identify, analyze, and use relevant situational information to make informed decisions and take appropriate actions as a single resource.
- Develop appropriate strategies and tactics to accomplish objectives.
- Develop and prioritize work assignments in accordance with sawyer certifications and capabilities.
- Perform a saw team briefing, ensuring less-experienced sawyers are properly informed on strategies and tactics.
- Evaluate progress and make operational adjustments as needed.
- Provide status updates.

2. Participate in training and mentoring Basic (FAL3) and Intermediate (FAL2) Fallers in the classroom and field.

When to start task: As a qualified FAL1, a sawyer is expected to mentor and teach within the scope of their knowledge and abilities to ensure their own safety and development as well as that of the less-experienced sawyers working alongside them. Mentorship and teaching are critical for continued personal development and the development of future sawyers.

Specific resources to complete task:

- NWCG chainsaw training resources.
- Wildland Fire Lessons Learned Center.
- WFSTAR modules.
- NWCG Leadership Curriculum.

How to accomplish task:

- Facilitate formal training opportunities such as S-212, Wildland Fire Chainsaws.
- Participate in the evaluation and certification of less-experienced sawyers.
- Provide quality constructive feedback to less-experienced sawyers.
- Verify that concepts and techniques being taught are properly understood and the context of their usage is valid.
- Identify and correct safety concerns in a timely manner.
- Provide additional opportunities for learning and development in both classroom and field scenarios.
- Review and study injury and near miss reports to continue learning and knowledge development.
 - Seek opportunities to serve as a subject matter expert (SME) during FLAs or other learning reviews.

Manage Risk**1. Develop a Job Hazard Analysis or Risk Management Assessment for a chain saw operation.**

When to start task: As a FAL1 trainee or qualified FAL1, you are expected to understand the Risk Management Process clearly enough to outline the requirements of a Job Hazard Analysis or Risk Management Assessment.

Specific resources to complete task:

- Agency specific JHA or Risk Management documentation.
- Local or incident safety officer.
- Risk Management Process as outlined in the *IRPG*, PMS 212.

How to accomplish task:

- Identify and evaluate potential chainsaw operations.
- Identify associated hazards.
- Assess hazards for probability, severity, and exposure.
- Recognize the effects of human factors in managing risk.
- Develop controls or necessary mitigations to make informed risk decisions.
- Improve understanding of how Human Factors impact saw operations.
- Seek appropriate level of review and approval.

2. Recognize changes in operational complexity and report pertinent changes to the appropriate supervisor.

When to start task: Operational complexity is an ongoing assessment process. Sawyers should learn to recognize changes in operational complexity and report pertinent changes to the appropriate supervisor.

Specific resources to complete task:

- PMS 212 Complexity Fade Chart.
- *IRPG* (Communication Responsibilities).
- WFSTAR Module “When Complexity Changes.”
- Risk Management Process as outlined in the *IRPG*.

How to accomplish task:

- Utilize risk management assessment to determine viability of objectives.
- Utilize NWCG standard size-up process, complexity tools such as the PMS 212 Complexity Fade Chart, and experience to determine complexity.
- Identify trigger points when complexity changes and alternate mitigation methods are needed.
- Recognize and communicate when complexity exceeds sawyer capabilities or comfort level.
- Implement a go-no-go decision based upon operational complexity. A sawyer can always make the decision to not engage in saw operations.
- Ask for additional assistance from another experienced sawyer.
- Report pertinent changes to appropriate supervisor.

Perform Advanced Faller Specific Duties.

1. Able to develop and safely execute a plan to resolve low to high complexity saw operations that may require unconventional techniques to meet an objective.

When to start task: When engaging in saw operations, all sawyers should first perform a size up and complexity analysis of the situation then develop an appropriate plan.

Specific resources to complete task:

- PMS 212 Size-up Procedures (Page 11).
- PMS 212 Complexity Fade Chart.
- WFSTAR Chainsaw Operations Modules.

How to accomplish task:

- Employ prior experience, ability, and knowledge, analyzing and resolving complex cutting situations with limited options.
- Utilize the standard size-up process to identify elements of complexity that are not readily perceived and to develop mitigations that require use of unconventional techniques.
 - Analyze and communicate species, hazards, topography, seasonality, and geographic considerations affecting the cut plan.
 - Utilize local resources and knowledge, when possible, to gain better understanding of local factors.

- Utilize the chainsaw to complete low to high complexity brushing, bucking, limbing, and felling operations under a variety of conditions with proficiency, using conventional and unconventional techniques.
- Recognize the increased complexity that snags and hung-up trees present and make a go-no-go decision on mitigation.
- Utilize the chainsaw to complete low to high complexity direct and indirect fireline construction duties.
- Utilize the chainsaw to complete low to high complexity mop-up and securing duties as directed by fireline supervisor.
- Identify and safely mitigate hazards inherent with wildland urban interface (WUI) during chain saw operations.
- Any operation that has become unsafe or is beyond a sawyer's capabilities or comfort level should be turned down and communicated.
 - Develop alternate mitigation methods.
- Go-No-Go decision making – Continuously assess situation for changes in complexity.
 - When complexity does change, a new size up must be performed. When hazards cannot be mitigated a new objective needs to be considered.

2. Maintain certification and qualification by demonstrating proficiency of Advanced Faller knowledge and technical skill to a qualified Advanced Faller evaluator(s) per agency protocol.

When to start task: Prior to sawyer certification lapsing.

Specific resources to complete task:

- Evaluating sawyer qualified at same level or one position level higher per agency protocol.
- NWCG Interagency field sawyer certification form.

How to accomplish task:

- Seek opportunities to remain proficient at current qualification level. The knowledge and skills necessary to perform the duties of a FAL1 must be actively maintained through continuous engagement and practice.
- Properly record saw experience on Incident Qualifications and Certification System (IQCS) Responder Update Sheet, <https://iqcsweb.nwcg.gov/responder-documents>.
- Per agency requirements, perform a sawyer recertification on a triennial cycle.
- Provide updated sawyer evaluation to the Unit Training Officer to be entered into IQCS.

3. Display proficiency in recognizing the effects of specific tree anatomy which may influence the cut plan and defects contributing to failure. Teach less-experienced sawyers fundamental elements of tree anatomy.

When to start task: Hazard tree identification is an ongoing learning process. Sawyers must learn to identify tree species and defects related to failure throughout all field operations. Capitalize on opportunities to share knowledge and mentor other sawyers.

Specific resources to complete task:

- PMS 212, Chapter 4.
- Geographic area specific field guides.

- WFSTAR Hazard Tree video.
- Hazard Tree and Tree Felling Subcommittee documents.

How to accomplish task:

- Identify tree anatomy and defects contributing to failure. Develop cut plan with consideration of effects of known hazards.
 - Fire-weakened trees and necessary mitigations.
 - Rotten or compromised fiber and its effects on tree structure.
 - Recognize and adjust plan based on the effects of lean present.
 - Recognize and adjust plan based on canopy weight and distribution.
 - Recognize and identify tree species and common defects of each.
- Seek out official training and resources to broaden knowledge.
- Use local knowledge to identify gaps.
- Use a qualified person or identification references to assist in tree identification.

4. Demonstrate advanced knowledge of chainsaw components and proficiency in maintenance and repair.

When to start task: Prior to saw operations and continuously throughout.

Specific resources to complete task:

- Equipment owner’s manual.
- PMS 212 Chapter 5.
- Local or incident equipment repair resources.
- More experienced sawyers.
- Advanced mechanical training and references.
- Specialty tools.

How to accomplish task:

- Troubleshoot performance problems and correct advanced mechanical problems.
 - Perform thorough maintenance on chainsaw powerhead and guide bar. Recognize when components should be replaced.
- Demonstrate standard methods used to adjust the tuning of the chain saw carburetor with tachometer.
- Identify mechanical conditions that require shop mechanic repair.
- Mentor less-experienced sawyers in troubleshooting and repair.
- Identify and mark equipment as “out of service” per agency guidelines.

Intermediate Faller (FAL2)

The Intermediate Faller (FAL2) has demonstrated the proficiency to work unsupervised while engaging in moderate complexity fireline saw operations, including tree felling, bucking, brushing, and limbing. A FAL2 may perform FAL1 tasks under the direct supervision of a FAL1. The FAL2 may serve as a single resource or as a member of a firefighting crew or module and may at times be tasked to provide oversight to other Basic Fallers (FAL3). A FAL2 serving as part of a module, reports to a Firefighter Type 1 (FFT1) or one of the Single Resource Bosses (FELB, CRWB, ENGB, FIRB, HMGB). A FAL2 serving as a single resource reports to a Felling Boss (FELB), Strike Team/Task Force Leader (TFLD), or other assigned supervisor. The FAL2 works in the operations functional area.

Build the Team

1. Participates in the development and implementation of saw related objectives, priorities, and work assignments for saw team members.

When to start task: Any time you are engaged in saw operations, you may be asked to participate in the development of saw related objectives, priorities, and work assignments for the saw team members. Upon receiving a briefing from fireline supervisor, implement assignment as directed.

Specific resources to complete task:

- IAP.
- Maps.
- Additional project related information.
- IRPG briefing checklist.
- PMS 212.

How to accomplish task:

- Attend operational briefing. Additionally, always receive tactical briefing from supervisor. Clarify any directions as needed.
- Scout and validate objectives.
- Utilize appropriate strategies and tactics to accomplish objectives.
- Accept work assignments in accordance with sawyer certifications, capabilities, and assigned equipment.
- Perform a saw team briefing, ensuring less-experienced sawyers are properly informed on strategies and tactics.
- Evaluate progress and make operational adjustments as needed.
- Provide status updates.

2. Participate in training and mentoring Basic Fallers (FAL3) in the classroom and field.

When to start task: As a qualified FAL2, a sawyer is responsible to mentor and teach within the scope of their knowledge and abilities to ensure their own safety and development as well as that of the less-experienced sawyers working alongside them. Mentorship and teaching are critical for the development of future sawyers.

Specific resources to complete task:

- NWCG chainsaw training resources.
- PMS 212.

- Wildland Fire Lessons Learned Center.
- WFSTAR modules.
- NWCG Leadership Curriculum.

How to accomplish task:

- Take part in formal training opportunities such as S-212.
- Provide quality constructive feedback to less-experienced sawyers.
- Identify and correct safety concerns in a timely manner.
- Provide additional opportunities for learning and development in both classroom and field scenarios.

Manage Risk

1. Recognize changes in operational complexity and report pertinent changes to the appropriate supervisor.

When to start task: Operational complexity is an ongoing assessment process. Sawyers should learn to recognize changes in operational complexity and report pertinent changes to the appropriate supervisor.

Specific resources to complete task:

- PMS 212 Complexity Fade Chart.
- *IRPG* (Communication Responsibilities).
- WFSTAR Module “When Complexity Changes.”
- Risk Management Process as outlined in the *IRPG*.

How to accomplish task:

- Utilize risk management assessment to determine viability of objectives.
- Utilize NWCG standard size-up process, complexity tools such as PMS 212 Complexity Fade Chart, and experience to determine complexity.
- Identify trigger points when complexity changes and alternate mitigation methods are needed.
- Recognize and communicate when complexity exceeds sawyer capabilities or comfort level.
- Implement a go-no-go decision based upon operational complexity. A sawyer can always make the decision to not engage in saw operations.
- Ask for additional assistance from another experienced sawyer.
- Improve understanding of how Human Factors impact saw operations.
- Report pertinent changes to appropriate supervisor.

Perform Intermediate Faller Specific Duties

1. Able to develop and safely execute a plan to resolve low to moderate complex saw operations that may require use of unconventional techniques.

When to start task: When engaging in saw operations, all sawyers should first perform a size up and complexity analysis of the situation then develop an appropriate plan.

Specific resources to complete task:

- PMS 212 Size-up Procedures.
- PMS 212 Complexity Fade Chart.
- WFSTAR Chainsaw Operations Modules.

How to accomplish task:

- Utilize the standard size-up process to identify elements of complexity.
 - This may include species, hazards, topography, seasonality, and geographic considerations affecting the cut plan.
 - Utilize local resources and knowledge, when possible, to gain better understanding of local factors.
- Utilize the chainsaw to complete low to moderate complexity brushing, bucking, limbing, and felling operations under a variety of conditions with proficiency, using conventional and unconventional practices.
- Recognize the increased complexity that snags and hung-up trees present and make a go-no-go decision on mitigation.
- Utilize the chainsaw to complete low to moderate complexity direct and indirect fireline construction duties.
- Utilize the chainsaw to complete low to moderate complexity mop-up and securing duties as directed by fireline supervisor.
- Identify and safely mitigate hazards inherent with WUI during chain saw operations.
- Any operation that has become unsafe or is beyond a sawyer's capabilities or comfort level should be turned down and communicated.
 - Consider alternate mitigation methods.
- Go-No-Go decision making – Continuously assess situation for changes in complexity.
 - When complexity does change, a new size up must be performed. When hazards cannot be mitigated, consider a new objective.

2. Maintain certification and qualification by demonstrating proficiency of Intermediate Faller knowledge and technical skill to a qualified Intermediate or Advanced Faller evaluator(s) per agency protocol.

When to start task: Prior to sawyer certification lapsing.

Specific resources to complete task:

- Evaluating sawyer qualified at same level or one position level higher or more.
- NWCG Interagency field sawyer certification form.

How to accomplish task:

- Seek opportunities to remain proficient at current qualification level.
- Properly record saw experience on IQCS Responder Update Sheet.
- Per agency requirements, perform a sawyer recertification on a triennial cycle.
- Provide updated sawyer evaluation to the Unit Training Officer to be entered into IQCS.

3. Continue learning tree anatomy and defects contributing to failure, as well as teaching less-experienced sawyers fundamental elements of tree anatomy.

When to start task: Hazard tree identification is an ongoing learning process. Sawyers must learn to identify tree species and defects related to failure throughout all field operations. Capitalize on opportunities to share knowledge and mentor other sawyers.

Specific resources to complete task:

- PMS 212, Chapter 4.
- Geographic area specific field guides.
- WFSTAR Hazard Tree video.
- Hazard Tree and Tree Felling Subcommittee documents.

How to accomplish task:

- Identify tree anatomy and defects contributing to failure. Develop cut plan with consideration of effects of known hazards.
 - Partially rotten or compromised fiber and its effects on tree structure.
 - Recognize and adjust plan based on the effects of lean present.
 - Recognize and identify tree species and common defects of each.
- Seek out official training and resources to broaden knowledge.
- Use local knowledge to identify gaps.
- Use a qualified person or identification references to assist in tree identification.

4. Demonstrate knowledge of chainsaw components and proficiency in maintenance and repair.

When to start task: Prior to saw operations and continuously throughout.

Specific resources to complete task:

- Equipment owner's manual.
- PMS 212, Chapter 5.
- Local or incident equipment repair resources.
- More experienced sawyers.

How to accomplish task:

- Troubleshoot performance problems and correct minor mechanical problems in the field.
 - Perform thorough preventative maintenance on chainsaw powerhead and guide bar. Recognize when components should be replaced.
- Demonstrate standard methods used to adjust the tuning of the chain saw carburetor with tachometer.
- Identify mechanical conditions that require shop mechanic repair.
- Identify mechanical conditions that would create safety hazards to the user and tag equipment out of service as necessary.

Basic Faller (FAL3)

The Basic Faller (FAL3) is an entry-level chainsaw operator that serves as a member of a firefighting crew or module. The FAL3 engages in low complexity fireline saw operations, including tree felling, bucking, brushing, and limbing, and should be closely supervised during operations. A FAL3 may perform FAL2 tasks under the direct supervisor of a FAL2. The FAL3 reports to an Intermediate (FAL2) or Advanced (FAL1) Faller, a Firefighter Type 1 (FFT1), or one of the Single Resource Bosses (FELB, Crew Boss, Single Resource [CRWB], Engine Boss, Single Resource [ENGB], Firing Boss, Single Resource [FIRB], Helicopter Manager, Single Resource [HMGB]). The FAL3 works in the operations functional area.

Build the Team

1. Implements saw related objectives, priorities, and work assignments as directed.

What to start task: Upon receiving a briefing from fireline supervisor, implement saw related objectives, priorities, and work assignments as directed.

Specific resources to complete task: PMS 212

How to accomplish task:

- Receive tactical briefing from supervisor. Clarify any directions as needed.
- Scout work area.
- Utilize appropriate strategies and tactics to accomplish objectives.
- Accept work assignments in accordance with sawyer certifications, capabilities, and assigned equipment.
- Evaluate progress and make operational adjustments as needed.
- Provide status updates.

Manage Risk

1. Learn to recognize changes in operational complexity and report pertinent changes to the appropriate supervisor.

When to start task: Operational complexity is an ongoing assessment process. Sawyers should learn to recognize changes in operational complexity and report pertinent changes to the appropriate supervisor.

Specific resources to complete task:

- PMS 212 Complexity Fade Chart.
- *IRPG* (Communication Responsibilities).
- WFSTAR Module “When Complexity Changes.”
- Risk Management Process as outlined in the *IRPG*.

How to accomplish task:

- Learn to utilize risk management assessment to determine viability of objectives.
- Utilize NWCG standard size-up process, complexity tools such as PMS 212 – Complexity Fade Chart, and experience to determine complexity.
 - Learn to identify trigger points when complexity changes and alternate mitigation methods are needed.

- Learn to recognize when complexity exceeds sawyer capabilities or comfort level.
- Develop an understanding of how Human Factors impact saw operations.
- Learn to implement a go-no-go decision based upon operational complexity. A sawyer can always make the decision to not engage in saw operations.
- Ask for additional assistance from another experienced sawyer.
- Report pertinent changes to supervisor.

Perform Basic Faller Specific Duties

1. Able to develop and safely execute a cut plan to resolve low complexity saw operations using conventional practices.

When to start task: When engaging in saw operations, all sawyers should first perform a size up and complexity analysis of the situation then develop an appropriate cut plan.

Specific resources to complete task:

- PMS 212 Size-up Procedures (Page 11).
- PMS 212 Complexity Fade Chart.
- WFSTAR Module “When Complexity Changes.”

How to accomplish task:

- Utilize the standard size-up process to identify elements of complexity.
 - This may include species, hazards, topography, seasonality, and geographic considerations affecting the cut plan.
 - Utilize local resources and knowledge, when possible, to gain better understanding of local factors.
- Utilize the chainsaw to complete low complexity brushing, bucking, limbing, and felling operations as directed by fireline supervisor.
- Utilize the chainsaw to complete low complexity direct and indirect fireline construction duties as directed by fireline supervisor.
- Utilize the chainsaw to complete low complexity mop-up and securing duties as directed by fireline supervisor.
- Identify and safely mitigate low complexity hazards inherent with WUI during chain saw operations.
- Any operation that has become unsafe or is beyond a sawyer’s capabilities or comfort level should be turned down and communicated.
 - Consider alternate mitigation methods.

2. Maintain certification and qualification by demonstrating proficiency of Basic Faller knowledge and technical skill to a qualified Intermediate or Advanced Faller evaluator(s) per agency protocol.

When to start task: Prior to sawyer certification lapsing.

Specific resources to complete task: Evaluating sawyer qualified one position level higher or more. NWCG Interagency field sawyer certification form.

How to accomplish task:

- Seek opportunities to remain proficient at current qualification level.
- Properly record saw experience on IQCS Responder Update Sheet.
- Per agency requirements, perform a sawyer recertification on a triennial cycle.
- Provide updated sawyer evaluation to the Unit Training Officer to be entered into IQCS.

3. Learn to identify tree anatomy and defects contributing to failure.

When to start task: Hazard tree identification is an ongoing learning process. Sawyers must learn to identify tree species and defects related to failure throughout all field operations.

Specific resources to complete task:

- PMS 212 – Chapter 4.
- Geographic area specific field guides.
- WFSTAR Hazard Tree video.
- Hazard Tree and Tree Felling Subcommittee documents.

How to accomplish task:

- Learn identification of tree anatomy and defects contributing to failure, such as:
 - Partially rotten or compromised fiber.
 - Recognize the effects of lean on associated tree failures and how lean may affect cut plan implementation.
 - Recognize and identify common tree species.
- Seek out official training and resources to broaden knowledge.
- Use local knowledge to identify gaps.
- Use a qualified person to assist in tree identification.

4. Demonstrate a basic knowledge of chainsaw components, maintenance, and repair.

When to start task: Prior to saw operations and continuously throughout.

Specific resources to complete task:

- Equipment owner’s manual.
- PMS 212 – Chapter 5.
- Local or incident equipment repair resources.
- More experienced sawyers.

How to accomplish task:

- Demonstrate proper fueling procedures.
- Demonstrate the ability to identify and troubleshoot minor mechanical problems.
- Demonstrate the ability to perform preventative maintenance on chainsaw.
 - Routine powerhead maintenance.
 - Routine guide bar and chain maintenance including sharpening.

Appendix C: Crosscut Saws

Saws

Crosscut saws generally can be divided into two types, one, and two-person saws. The saws are also categorized into felling saws and bucking saws.

One-Person Crosscut Saws

- A one-person crosscut saw's blade is asymmetrical.
- The saw has a D-shaped handle.
- The saw also has holes for a supplemental handle at the point (tip) and the butt (near the handle).
- The saws are usually three to four and half feet long.

Figure: One-person crosscut saw.



Two-Person Crosscut Saws

- Two-person crosscut saws are symmetrical.
- The saws cut in both directions on the pull stroke.
- Two-person crosscut saws manufactured today are of equal width (flat ground).

Figure: Two-person crosscut saw.



Felling Saws

- Felling saws are best suited for felling standing timber in a horizontal position. Felling saws have a concave back and a narrower width than bucking saws which provide certain advantages.
 - The saws are more flexible.
 - The saws are lighter, so less effort is needed to use it.
 - There is more space to insert a wedge sooner.
- Crosscut saws usually have two handles. Many vintage felling saws have one handle hole in each end.
- Because felling saws are flexible, they do not make a good bucking saw or a general all-around utility saw.

- The bucking saw is recommended as the standard saw for most trail and construction applications.

Bucking Saws

- Bucking saws have a straight back and are thicker than felling saws making them heavier and stiffer.
- Because the bucking saw usually is operated by one person, it cuts on both the push and pull strokes.
- The additional stiffness helps prevent the saw from buckling on the push stroke. Bucking saws can also be used for felling but do not perform as well.

Figure: Comparison of felling and bucking saws.



Vintage Saws

- Many people consider vintage saws superior to modern saws in overall performance and craftsmanship.
- These saws are either straight taper, crescent taper, or flat ground (variation in thickness).
- Most vintage saws had teeth all the way to the ends and removeable handles.

Crescent Taper Ground

- The best vintage saws are crescent taper-ground and offer the most clearance in the kerf of any of the grinds.
- Crescent saws taper in width from teeth to back edge and in length between the middle of the saw to the handles.
- The thinnest section is the back and in the middle. These saws require the least amount of set with the narrowest kerf.

Definitions

- Saw Grinds – Grinds describe the variations in thickness in a crosscut saw.
- Flat Ground – The saw's thickness is the same throughout. Saws manufactured today are flat ground.
- Straight Taper Ground – The saw is thinner at the back than at the center which gives it more clearance and reduces bind.
 - Straight taper-ground saws require less set as they are less apt to bind.
- Set – Set is defined as the amount that each cutter is bent outward from the center.

Figure: Comparison of cuts made by straight taper-ground and flat-ground saws.

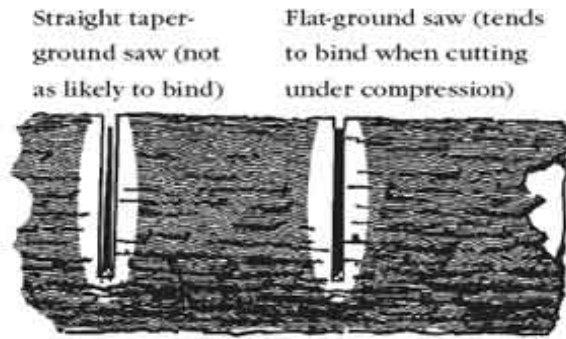
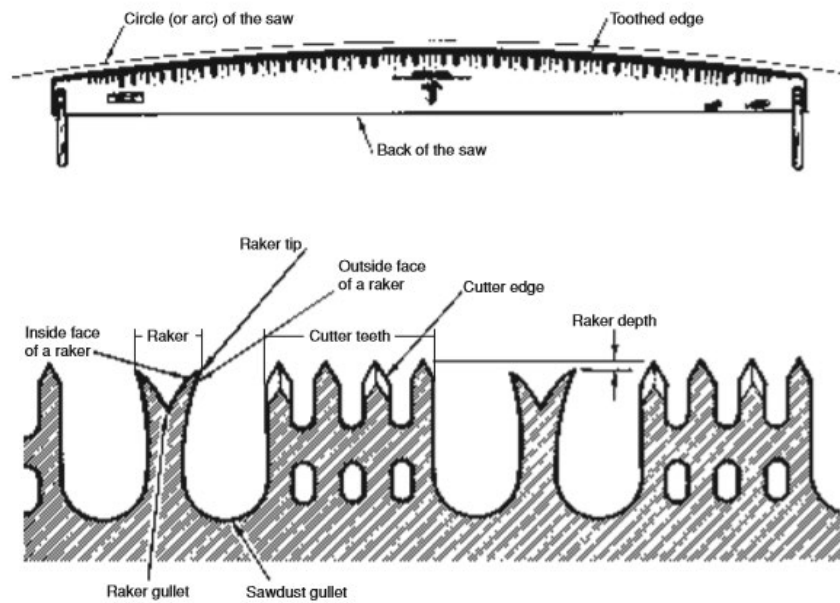

Figure: Parts of a crosscut saw



How a Saw Cuts

- A saw functions like a series of knives that make up the teeth. This creates simultaneous parallel cuts and releases the wood between them.

Cutter Teeth

- Crosscut saws are made up of two rows of cutting edges.
- The saw releases wood fibers on each side of the kerf as it passes through a log.
- Cutters work best in brittle, seasoned wood.

Figure: How a crosscut saw cuts.



Rakers

- The rakers break loose the cut fibers and remove them from the log as the saw is pushed and pulled.
- Unlike a chainsaw where rakers set the cutting depth, crosscut rakers chisel out the sections that have been cut or scored by the cutters.

Gullets

- Gullets are the spaces between cutters or groups of cutters. Gullets must be large enough to store all the shavings until the saw exits the kerf.
- The longer the saw the larger the gullets need to be.
- A gullet in the middle of a three-foot log must travel one and half feet to clear its shavings on either side.

Saw Handles

- A one-person saw has a fixed D-shaped handle with additional holes on the top of the saw to attach a supplemental handle.
- Many two-person crosscut saws, usually bucking saws, have two holes on each end for handles.
- Moving the handle from the lower hole has the same effect as moving the hands several inches up the saw handle.
- With the handle in the upper hole, a push stroke applies more downward force on the saw, causing the teeth to sink deeper into the wood.
- The deeper cut requires more force on the pull stroke.

Maintenance

Saw Maintenance

Cleaning

- Clean and lubricate saws at the end of the day or before storing.
- Resin deposits on the lower part of the teeth and in the gullets will produce drag unless removed.

- Clean the saw with an environmentally acceptable solvent and apply a thin coat of petroleum-free lubricant. Some pitch can be removed with solvent while the saw is cutting, allowing the saw's motion to scrub away the buildup.
- Pitch buildup can be removed at the end of the day with steel wool and a cleaning solution. Petroleum-free lubricants, such as canola oil can also help soften resin deposits. While cutting, squeeze bottles allow the sawyer to direct a stream of lubricant onto the saw's surface.
- In damp or wet conditions swollen wood fibers cause the saw to drag and may require additional lubrication.

Removing Rust

- Rust probably does more damage to saws than anything else.
- Remove light rust using steel wool and a pumice block or a wire brush for heavier rust.
 - Never use a power sanding disk.
- As rust and other deposits are removed, you will see imperfections in the saw blade. Spots that are shinier than the rest of the saw are high spots and duller ones are low.
- These high and low spots will need to be hammered out by someone with filing and maintenance experience.

Troubleshooting

- Check the saw periodically for straightness. A saw that is not straight can buckle on the push stroke. The narrower, lighter felling saws are more prone to buckling.
- Two combination square rules can be used as straightedges.
- After removing handles and hanging the saw vertically move the straightedges as a pair with the saw between them while feeling for resistance.
- You will feel increased drag on the ends of the straightedge on depressions and a high point on the opposite side.
- Even resistance on both straightedges reflects a straight saw without kinks, bends, or bumps. Mark irregularities for straightening.

Testing the Saw

- Testing determines whether a saw cuts straight and runs smooth.
- The saw should produce long, thick shavings with smooth edges. Green trees produce longer shavings than dry wood.
- Shavings with whiskers or irregularities indicate rakers that are too long. Paper thin shavings indicate rakers that are too short.

Figure: Examine shavings to identify sharpening problems.

Examining shavings for sharpening problems



- If the saw consistently pulls to one side through no fault of the sawyer, the saw needs additional maintenance.
- Too much set on one side of the cutters can cause the saw to pull to that side. If a saw has been sharpened improperly, the teeth may be longer on one side than the other.
- The saw will pull to the side with the longer teeth.
- If a saw feels like it is snagging the wood, it is probably because one or more rakers have been filed incorrectly. Inconsistent set in the teeth also can produce a jumpy saw.

A qualified saw filer will need to both sharpen and make any adjustments. Never field sharpen or touch up dull cutters; doing so shortens the teeth, compounding the problem. The Crosscut Saw Manual (7771-2508-MTDC, revised 2003) by Warren Miller is an excellent resource for more information on saw maintenance and filing, <https://www.fs.fed.us/t-d/pubs/htmlpubs/htm77712508/toc.htm>.

Brief Overview of Saw Filing Procedures

Specialized tools are needed to file saws. Filing must be done by a qualified filer in a saw shop.

- Saw Vises and Tools – A filer needs to work in a well-lit location with a wooden vise to hold the saw.
- Straightening – Straightening is an art. The filer must move the metal carefully by hammering the blade on an anvil.
- Jointing – After the saw has been cleaned and straightened, jointing is the first step in sharpening. A tool called a jointer holds the file. The points are filed off the cutter tips so that each of them lies on the circle of the saw.
- Fitting Rakers – The raker gullet is shaped using a triangular file. The raker is lowered and checked with a pin gauge, which establishes the exact clearance below the cutters.
- Tooth Pointing – Each tooth is sharpened to a point. The filer has the option to make the bevel suit the type of wood the saw is being used to cut.
- Setting Teeth – The teeth need to be set so they lie directly behind one another. The filer puts equal set in all the teeth by hammering the points over a beveled hand anvil. The set is checked using a tool called a spider.

Storage

- Because saws are difficult to sharpen, extreme care must be used storing saws. After transporting, do not store a saw in a sheath or with a guard on it because it could trap moisture next to the saw's teeth. Anything in direct contact can easily damage a saw.
- Storage in the field can occur but the saw needs to be wiped clean and rubbed with lubricant before you leave them. Remove the saw handles and sheaths, animals often gnaw on the wooden handles.
- To store a saw long term, apply a coating of heavy oil or grease diluted with solvent. It is best to remove the handles and hang the saw from a nail through a handle hole. Removing the handles will also prevent oil on the saw to bleed into the wood.
- Never leave a saw in a bent or leaning position to prevent permanent bends.

Transporting Saws

- Sheaths protect the saw from damage or inflicting injury.
- A split length of old firehose makes a good crosscut saw sheath. Wipe the hose's rubber inner lining with an oily rag to reduce the chance of rust.
- Attach the firehose to the saw using parachute cord or Velcro.
- Saws are difficult to transport because they are long and flexible. Vintage saws can be bent to make them easier for hikers or pack stock to carry. Be sure to straighten a saw after transporting. Modern saws should not be bent, the softer metal will hold the bend.

Crosscut Bucking

Safety

- The same principles apply as for chainsaw bucking but the sawyer is exposed to risks longer during crosscut saw operations.

Planning

- The saw should be twice as long as the log's diameter plus six inches. For example, a three-foot log will need at least six feet of saw so that each sawyer has at least one and half feet of saw blade clearing the log on each pull to deposit wood shavings from the gullets. Failure to accommodate full clearance will result in increasing friction and difficult cutting.

Types of Cuts

- Three basic types of bucking cuts are straight cuts, compound cuts, and offset cuts.
 - A straight cut is made through the log from one side. It can be performed by single or double bucking. It also can be cut from underneath the log by a single sawyer.
 - A compound cut is placed at an angle less than perpendicular to the log and angled so that the bottom of the cut slopes toward the part of the log that is being removed. This cut typically is used when clearing a large log that is across a trail.
 - The offset cut is placed so that the bottom under stumpbucking cut does not match up exactly with the top cut. The offset wood prevents a suspended log from damaging the saw when the log drops.

Figure: Straight, compound, and offset cuts.

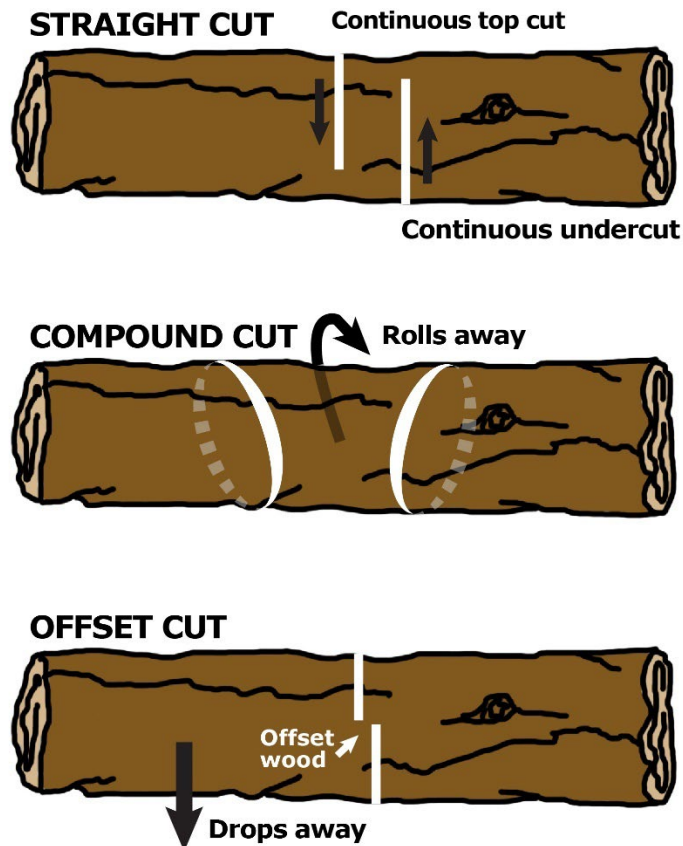

Straight, compound, and offset cuts.

- Single Bucking refers to one sawyer on the saw where double bucking is one sawyer on each end of the saw. There are advantages to each. New sawyers should master the skill of single bucking before double bucking to learn how to cut smoothly without buckling.
- The stiffer, heavier bucking saw is easier to push during single bucking while thinner, lighter felling saws are difficult for new sawyers.

Single or One-Person Bucking Advantages

- The sawyer starts out double bucking and needs to finish the cut from one side because of safety considerations or log movement.
- The log is too large for the length of the saw.
- The sawing sequence starts or ends with underbucking, which can be done only by a single sawyer.
- A single sawyer can take off the handle at one end of the saw. That end of the saw can be drawn into the log, allowing the shavings to be removed from the gullets.

Underbucking

Underbucking is crosscutting from the bottom of a log up. The term underbuck is also used to describe a mechanical guide for the saw as it cuts and provides a fulcrum advantage by creating downward pressure on the saw.

Mechanical underbucks are not available commercially but an ax with a series of 30 to 45 degree notches can be used. Simply drive the ax in parallel to the log and use one of the notches as a guide for the back side of the saw.

- Begin cutting through as much of the compression wood on top without pinching the saw.
- Line up the underbuck grooves in the ax handle with the top saw kerf and swing the ax into the log forcefully.
- Place the back of the inverted saw in the underbuck groove.
- With a light downward pressure on the underbuck, push the saw forward maintaining consistent pressure on the push and pull strokes. A lubricant will minimize friction between the axe handle and the saw.

Figure: An ax with notched grooves planted in the lower part of the log can work as an underbuck.



Bottom bind is when there is bottom bind and too little room to get the saw under the log for an undercut, all the cutting will be done from the top. Wedges will need to be used.

Side bind is one of the most difficult and hazardous situations involving binds. If there is room below the log for the saw's end to clear, cut the side with compression wood first.

Alternately saw and chop out wood with an ax. The saw should be in a nearly vertical position. The finish cut is on the side with tension wood from a safe position.

Two-Person Cutting

- Always pull, never push! Allow your partner to pull. Pushing may cause the saw to buckle.
- As one sawyer pulls, the other sawyer keeps a relaxed grip on the handle.
- Be sure the saw travels into and out of the kerf in a straight line and the saw remains parallel to the ground.
- Be cautious of dirt and rocks.
- When the cut is finished remove the handle on the downhill side of the saw and allow the uphill sawyer to pull the saw free.

Crosscut Felling

Felling principles are the same as with a chainsaw. Additional communication is needed for two-person cutting as there is additional exposure with cuts that take longer. Backcuts are similar as with a chainsaw except if two sawyers are working together, identify who will take the saw to the escape path. There are different ways to make the undercut.

Three Undercut Options:

Chop out the undercut with an ax.

- As fast as sawing for smaller trees.
- An option in restricted areas where one side of the tree does not offer standing room for the sawyer or clearance for a saw.
- Because it can be difficult to apply lubricant to the bottom edge of a horizontal saw chopping out the undercut may be easier if the tree is extremely pitchy.

Horizontal cut with a saw and sloping cut with an ax.

- Easier to make a horizontal bottom cut.
- Easier to mitigate dutchmans.

Both cuts with a saw.

- On large trees it may be easier to use a crosscut saw for the sloping cut than an axe. Both the sloping cut, and the backcut are the same as with a chainsaw.

The *NWCG Standards for Wildland Fire Chainsaw Operations*, PMS 212, is developed and maintained by the Hazard Tree and Tree Felling Subcommittee (HTTFS), under the direction of the Risk Management Committee (RMC), an entity of the National Wildfire Coordinating Group (NWCG).

Previous editions: 2021.

While they may still contain current or useful information, previous editions are obsolete. The user of this information is responsible for confirming that they have the most up-to-date version. NWCG is the sole source for the publication.

This publication is available electronically at <https://www.nwcg.gov/publications/212>.

Submit comments, questions, and recommendations to the appropriate agency program manager assigned to the HTTFS. View the complete roster at <https://www.nwcg.gov/committees/hazard-tree-and-tree-felling-subcommittee/roster>.

Publications and training materials produced by NWCG are in the public domain. Use of public domain information, including copying, is permitted. Use of NWCG information within another document is permitted if NWCG information is accurately credited to NWCG. The NWCG logo may not be used except on NWCG authorized information. “National Wildfire Coordinating Group,” “NWCG,” and the NWCG logo are trademarks of NWCG.

The use of trade, firm, or corporation names or trademarks in NWCG products is solely for the information and convenience of the reader and does not constitute endorsement by NWCG or its member agencies of any product or service to the exclusion of others that may be suitable.

This NWCG publication may contain links to information created and maintained by other non-federal public and/or private organizations. These organizations may have different policies from those of NWCG. Please note that NWCG does not control and cannot guarantee the relevance, timeliness, or accuracy of these outside materials.